

# **HAKKO FR-811**

**SMD REWORK STATION**

SMD Rework Station with Vacuum Pickup

## **Instruction Manual**



Thank you for purchasing the HAKKO FR-811 SMD Rework Station.  
This unit features digital control and display of hot air temperature.  
Please read this manual before operating the HAKKO FR-811.  
Keep this manual readily accessible for reference.



### **TABLE OF CONTENTS**

1. PACKING LIST .....	1
2. SPECIFICATIONS .....	1
3. WARNINGS, CAUTIONS, AND NOTES .....	2
4. PART NAMES .....	3
5. INITIAL SETUP.....	5
6. OPERATION .....	8
7. CONNECTION WITH PC .....	19
8. PARAMETER SETTING.....	26
9. TEMPERATURE DISTRIBUTION CHART.....	35
10. MAINTENANCE / INSPECTION .....	38
11. ERROR MESSAGE .....	39
12. TROUBLE SHOOTING GUIDE .....	40
13. PARTS LIST .....	41
14. WIRING DIAGRAM .....	46

# 1. PACKING LIST

Please check to make sure that all items listed below are included in the package.

HAKKO FR-811 station .....	1	Heat resistant pad .....	1
Grip stand assembly .....	1	Vacuum pipe control knob (L) (with Tapping screw) .....	1
Power cord .....	1	Pads (ø3 mm (0.12 in.), ø5 mm (0.20 in.), ø7.6 mm (0.3 in.)) .....	2 each
USB cable .....	1	Thermocouple .....	1
Software (CD-ROM) .....	1	Instruction Manual .....	1
		Temperature distribution chart .....	1

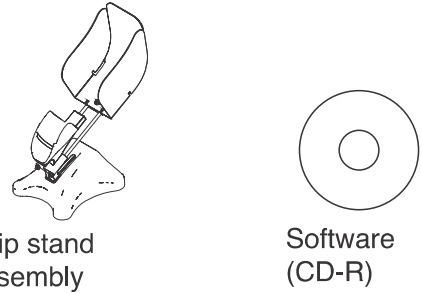
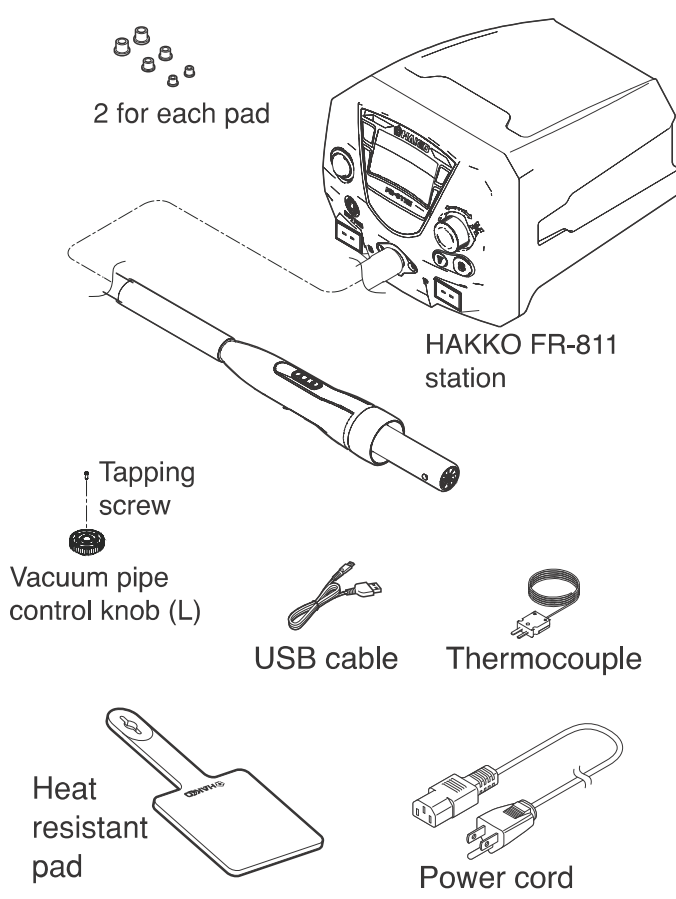

※Compatible model

Bottom Heater

C5013 (100V 3 wired cord & American plug)

C5014 (110V 3 wired cord & American plug)

C5015 (127V 3 wired cord & BR plug)

C5016 (120V 3 wired cord & American plug)

C5017 (220V 3 wired cord & American plug)

C5018 (220V 3 wired cord & Chinese plug)

C5019 (220V 3 wired cord & European plug)

C5020 (220V 3 wired cord & BR plug)

C5021 (230V 3 wired cord & BS plug)

C5022 (230V 3 wired cord & SI plug)

C5023 (230V 3 wired cord & European plug CE)

C5024 (230V 3 wired cord & BS plug CE)

C5025 (220-240V 3 wired cord but no plug)

C5026 (230-240V 3 wired cord & Australian plug)

C5037 (220V 3 wired cord & European plug KTL)

# 2. SPECIFICATIONS

Power consumption	100V-700W 110V-840W 120V-820W 220V-1100W 230V-1200W 240V-1300W
-------------------	---

### ● Handpiece

Power consumption	100V-670W 110V-810W 120V-790W 220V-1070W 230V-1170W 240V-1270W
Total length (w/o cord)	250 mm (9.8 in.)
Weight (w/o cord)	180 g (0.40 lb.)

\*This product is protected against electrostatic discharge.  
\*Specifications and design are subject to change without notice.

### ● Station

Power consumption	30 W
Capacity (Airflow)	001 - 100% (5 - 115L/min*)
Control temperature	50 - 600°C (120 - 1120°F)
Outer dimensions	160(W) × 145(H) × 220(D) mm (6.3 × 5.7 × 8.7 in.)
Weight	1.5 kg (3.3 lb.)

\* Airflow capacity is rated as free flowing. Restrictions created by various nozzles may reduce the maximum airflow capacity.

### ⚠ CAUTION

This product includes such features as electrically conductive plastic parts and grounding of the handpiece and station as measures to protect the device to be soldered from the effects of static electricity. Be sure to observe the following instructions:

1. The handle and other plastic parts are not insulators, they are conductors. When replacing parts or repairing, take sufficient care not to expose live electrical parts or damage insulation materials.
2. Be sure to ground the unit during use.

# 3. WARNINGS, CAUTIONS AND NOTES

Warnings, cautions and notes are placed at critical points in this manual to direct the operator's attention to significant items. They are defined as follows:

 **WARNING:** Failure to comply with a WARNING may result in serious injury or death.

 **CAUTION :** Failure to comply with a CAUTION may result in injury to the operator, or damage to the items involved.

**NOTE :** A NOTE indicates a procedure or point that is important to the process being described.

## **WARNING**

To avoid damage to the unit, do not turn the power switch OFF until the pump stops automatically by cooling down after use.

When powered, the temperature of the hot air and the nozzle will become extremely hot, reaching a maximum temperature of 600°C (1120°F). Be sure of the following to avoid possible **burns / fires** :

- Do not direct the hot air toward personnel or touch the metal parts near the nozzle.
- Do not allow the nozzle to come close to, or touch, flammable materials.
- Inform others in the area that the unit is hot and should not be touched.
- Turn the power off and allow the unit to cool when changing parts or storing the HAKKO FR-811.
- This unit is for counter or workbench use only.
- This appliance can be used by children aged from 8 years and above and persons with reduced physical, sensory or mental capabilities or lack of experience and knowledge if they have been given supervision or instruction concerning use of the appliance in safe way and understand the hazards involved.
- Children shall not play with the appliance.
- Cleaning and user maintenance shall not be made by children without supervision.

To prevent accidents or damage to the HAKKO FR-811, be sure to observe the following:

## **CAUTION**

- Turn the power off when not in use, or left unattended.
- Do not strike the handpiece against hard surfaces or otherwise subject it to physical shock.
- Be sure the unit is grounded. Always connect power to a grounded receptacle.
- Do not modify the unit.
- Use only genuine HAKKO replacement parts.
- Do not allow the HAKKO FR-811 to become wet, or use it when hands are wet.
- Remove the power cord by holding the plug - not the cord.
- Be sure the work area is well ventilated.

# 4. PART NAMES

## ● Station

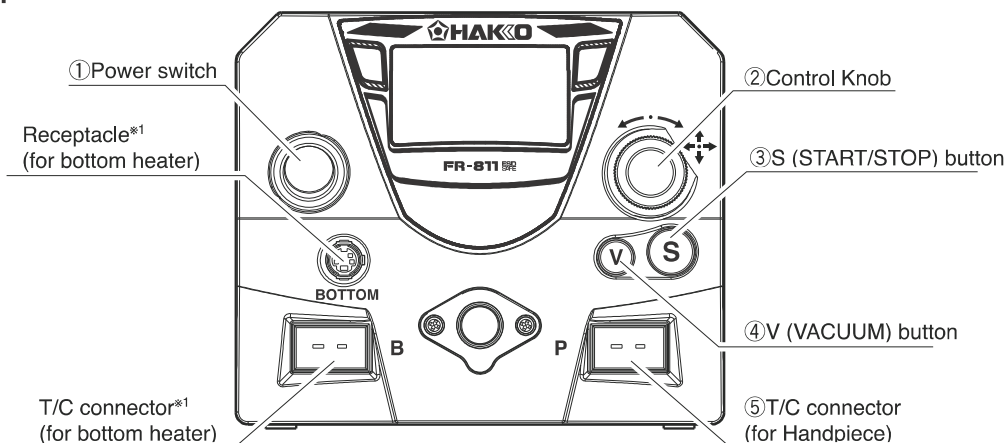

※1 Refer to the “■ Connection with the bottom Heater” in page 28.

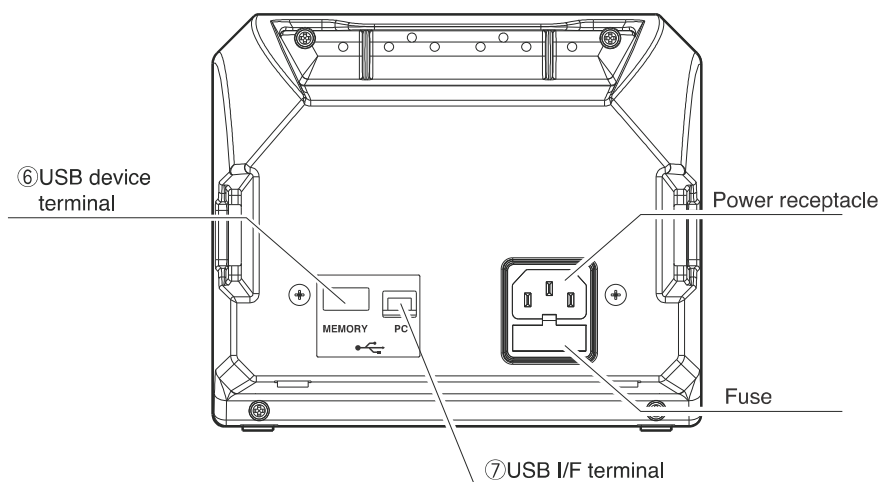

### ① Power switch

This switch turns the power ON and OFF.

### ② Control Knob

There are 4 main types of control knob operations.

- Turning the control knob left or right changes values or changes the selected item.
- Tilting the control knob left or right shifts the selected position or changes the selected item.  
 (Example: When the hundreds digit in the temperature setting screen is blinking, tilting it once to the right will shift the selected position to the tens digit.)
- Tilting the control knob up or down changes the selected item.
- Pressing the center of the control knob confirms input of data values and ends the input mode for that data.

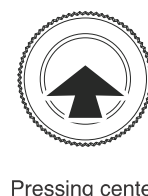
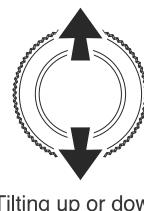
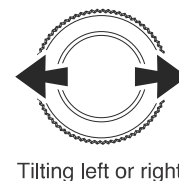
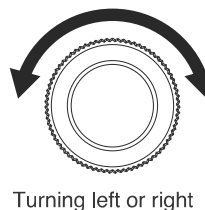
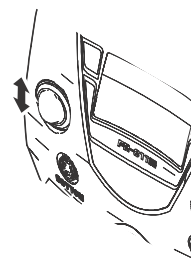

③S (START/STOP) button

• MANUAL mode

Pressing this button once starts the blowing of hot air.

Pressing this button again starts cooling down, and when the temperature has reached 100°C or 90 seconds since the start of cooling has passed, the blowing of air is automatically stopped.

• AUTO mode

Pressing this button once starts the program.

Pressing this button again starts cooling down, and when the temperature has reached 100°C or 90 seconds since the start of cooling has passed, the blowing of air is automatically stopped.

④V (VACUUM) button

Pressing this button switches the vacuum pump ON and OFF.

⑤T/C connector (Labeled with "P"; for parts)

Insert the thermocouple in the thermocouple connector; then, bring the tip of the thermocouple into contact with any location where you want to take measurements.

**⚠ CAUTION**

If the measurement unit is lower than the temperature of the internal station, you will see the temperature inside the station is on the monitor.

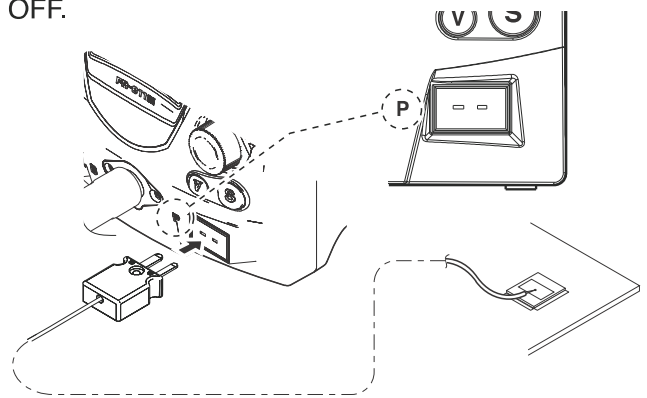

When selecting the "Part" (refer to the "Sensor selection" in page 11), HAKKO FR-811 can make control from part temperature during the measurement.

**NOTE :**

- A  $\varnothing 0.1$ mm thermocouple (B5127) is sold separately. It can be used for measuring the temperature in gaps, etc. into which the  $\varnothing 0.2$ mm thermocouple cannot fit.
- Heat-resistant tape (B5130; 100 strips) is sold separately. It can be used for attaching a thermocouple to a part.

⑥USB device terminal

A USB memory device can be plugged into this terminal and data can be stored onto the device, read from the device, etc.

**⚠ CAUTION**

- When using a USB memory device, be careful of static electricity.
- When using a USB memory device, be careful not to bump the device against objects or drop the device.

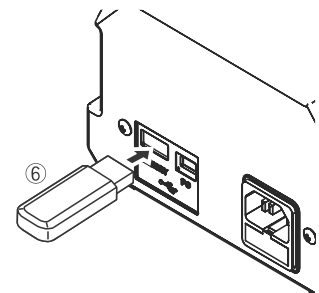

⑦USB I/F terminal

A USB cable can be plugged into this terminal for connection with a PC.

By connecting the HAKKO FR-811 to a PC, the PC can be used for performing settings or for storing or reading data.

(refer to the "7. CONNECTION WITH PC" in page 19)

**⚠ CAUTION**

USB memory and a USB cable can not be used at the same time.

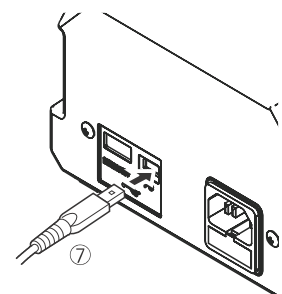

## ● Handpiece

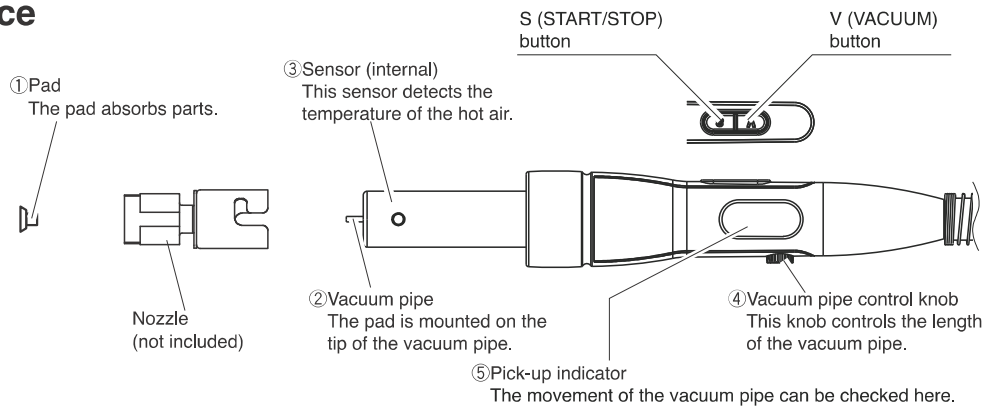

# 5. INITIAL SETUP

## A. Station

### ● Connections

1. Connect the power cord to the power receptacle on the rear of the station.
2. Connect the thermocouple to the T/C connector.  
(When using in T/C mode)

#### ⚠ CAUTION

- If connection is not performed properly, an error will be displayed.
- There are T/C connectors for the handpiece side (Labeled with "P") and the bottom heater side (Labeled with "B"). Be sure to connect the thermocouple to the proper T/C connector.

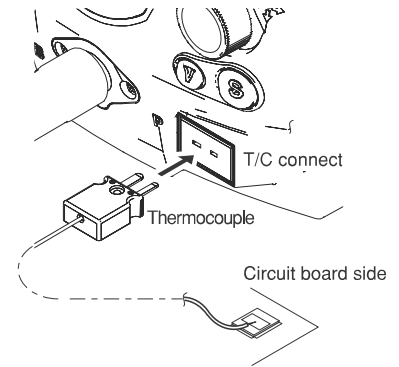

3. Plug the power cord into a wall socket.  
Check that the power switch is set to OFF and then plug in the power cord.

#### ⚠ CAUTION

This product is ESD-protected. Be sure to use a grounded wall socket.

## B. Handpiece

#### ⚠ CAUTION

The nozzle and pad will be heated at high temperature. Cool them before replacement.

#### NOTE:

The handpiece can be used with the provided vacuum pipe control knob (L).

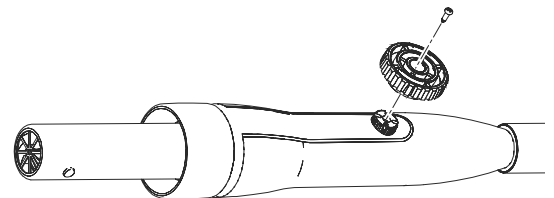

### ● Using vacuum function operative nozzle

#### 1. Attach the nozzle.

- a. Extend the vacuum pipe using the vacuum pipe control knob.
- b. Pass the vacuum pipe through the nozzle hole and attach the nozzle.

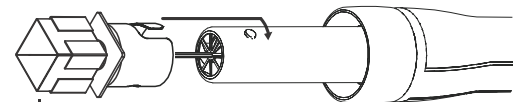

#### ⚠ CAUTION

- Vacuum pipe  
Do not use excessive force. When not using a nozzle, retract the vacuum pipe to the shortest length.

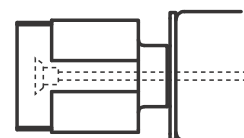

## 2. Attach the pad.

- a. Attach the pad.
- b. Adjust the pad to an appropriate position.  
Adjust the vacuum pipe so that the pipe and pad protrude as little as possible.

### ⚠ CAUTION

#### ● Pad

The pad does not last indefinitely. When it becomes deteriorated, replace it. Since exposure to high temperatures causes it to deteriorate faster, Hakko recommends it be cooled after use.

## ● Using vacuum function inoperative nozzle {N51-01(G), N51-05(G)}

- a. Retract the vacuum pipe to the shortest length using the vacuum pipe control knob.

### ⚠ CAUTION

The new N51-01/N51-05 nozzle has a pipe guard inside. These nozzles could not be attached to HAKKO FR-811 when the vacuum pipe is extended. Do not use excessive force.

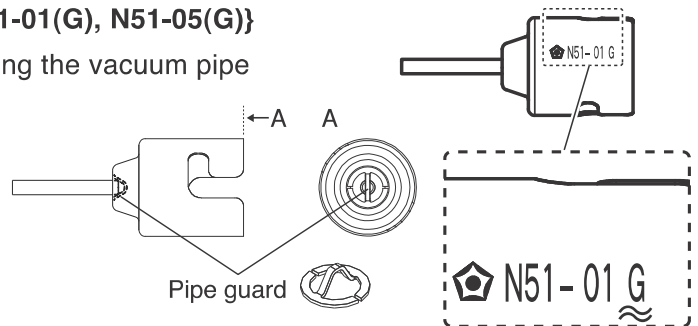

- b. Tighten the nozzle mounting screw.

### ⚠ CAUTION

When "G" is not marked on the nozzle, these nozzles do not have space to blow hot air. Using them with the HAKKO FR-811 may result in danger.

### NOTE :

Letter "G" is marked on the nozzle with the pipe guard.

## ● How to Use a old nozzle

Align the projection part, attach the old nozzle to the heater pipe.

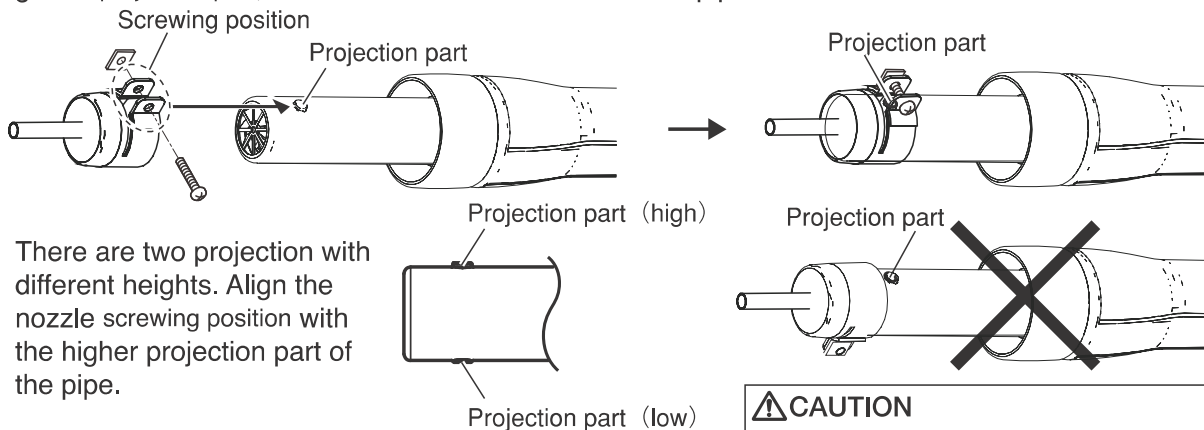

There are two projection with different heights. Align the nozzle screwing position with the higher projection part of the pipe.

※When using the QFP nozzle, remove the inside screw (M3 × 5) of the nozzle.



### ⚠ CAUTION

When attached in the wrong direction, the nozzle could not be fully inserted and can cause air leakage. Make sure to attach the nozzle in the correct direction.

### ⚠ CAUTION

#### ● Vacuum function inoperative nozzles. (Old nozzle)

A1124B, A1130, A1131, A1132, A1133, A1134, A1142B, A1183, A1190, A1191, A1192, A1325  
These nozzles could not be attached to HAKKO FR-811 when the vacuum pipe is extended. Do not use excessive force.

A1124, A1142

Do not use these nozzles with HAKKO FR-811. These nozzles do not have space to blow hot air, using them with the HAKKO FR-811 may result in danger.

## C. Grip stand assembly

- Set up the grip stand assembly.  
Set up the grip stand assembly in the figure below steps.

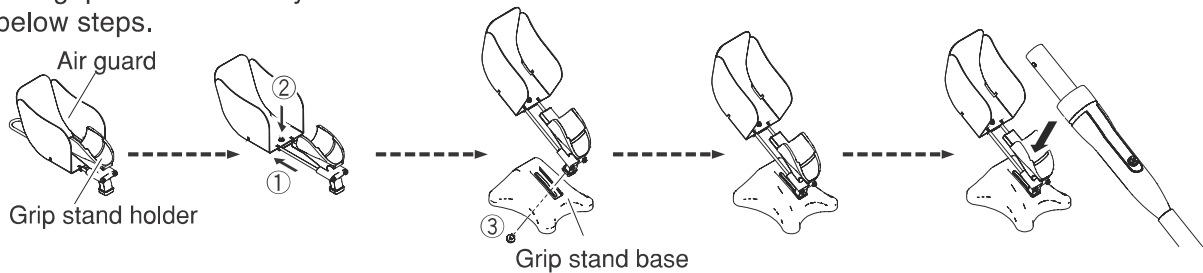

### \*Change the direction of the air guard

Change the mounting direction of the air guard.

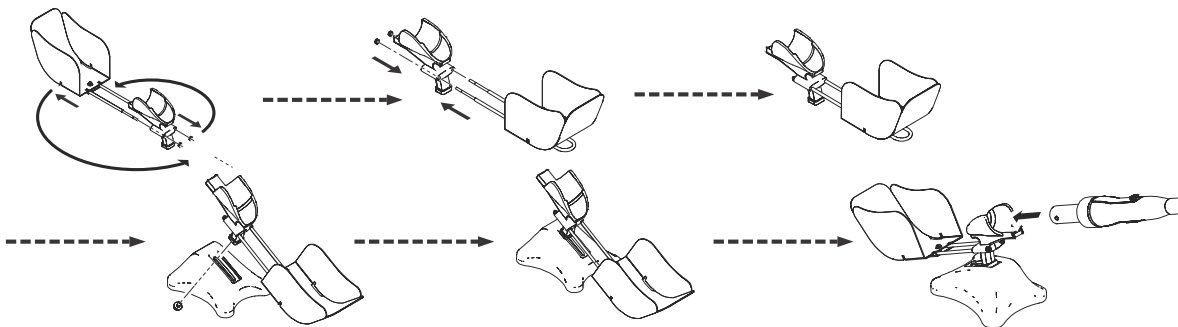

#### ⚠ CAUTION

When you change the orientation, please adjust as air guard does not hit the ground.

## D. Electrical Connection and Power ON

1. Connect the power cord to the power receptacle on the back panel of the station.
2. Place the handpiece on the grip stand assembly.
3. Plug the power cord into a grounded wall socket.
4. Turn the power switch ON.

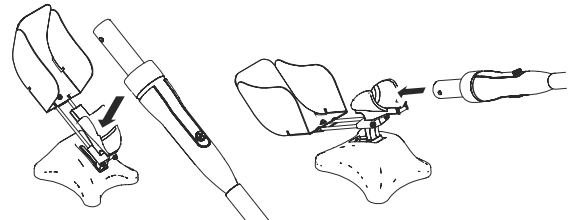

#### ⚠ CAUTION

- Vacuum pipe  
Do not use excessive force. When not using a nozzle, retract the vacuum pipe to the shortest length.

#### ⚠ CAUTION

When not in use, place the handpiece on the grip stand assembly.

#### ⚠ CAUTION

The HAKKO FR-811 is protected against electrostatic discharge and must be grounded for full efficiency.

\*When you place the handpiece to the grip stand assembly, operation is stopped. In this case, it does not work when you press the S button.

## E. Setting Date & Time

When you first turn on the power to make the setting of the date.

Set in the following operation



Changes the selected item



Changes values



Enter

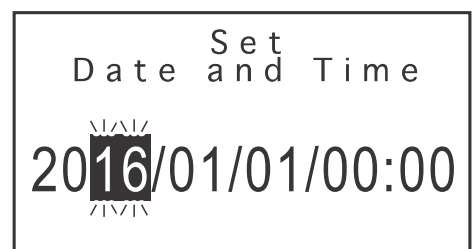



# 6. OPERATION

## ● INSTALL/REMOVE

### ● Installation

Apply an appropriate amount of solder paste to the P.W.B.

#### ① Part suction and positioning

Have the part sucked by the pads and position the part on the P.W.B.

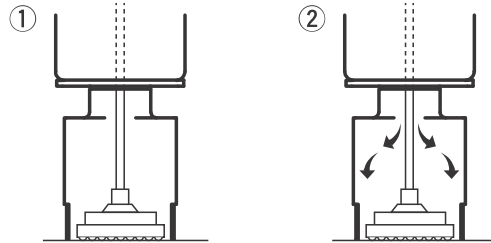

#### ② Heating

Hot air blows from the nozzle to melt the solder.

#### ③ Cooling

Heater is stopped, cooling begins.

#### ④ Lift the handpiece

Make sure the solder has hardened before lifting the handpiece.

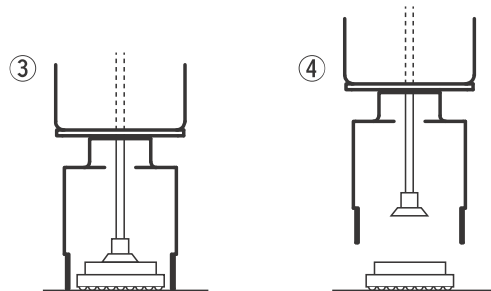

### ● Removal

Mount the nozzle and pads on the part to be removed.

#### ① Heating

Hot air blows from the nozzle and melts the solder.

#### ② Part removal

Lift the handpiece and remove the part from the P.W.B.

#### ③ Releasing the removed part

Release the removed part, turn off the vacuum.

#### ④ Cooling

Heater is stopped, cooling begins.

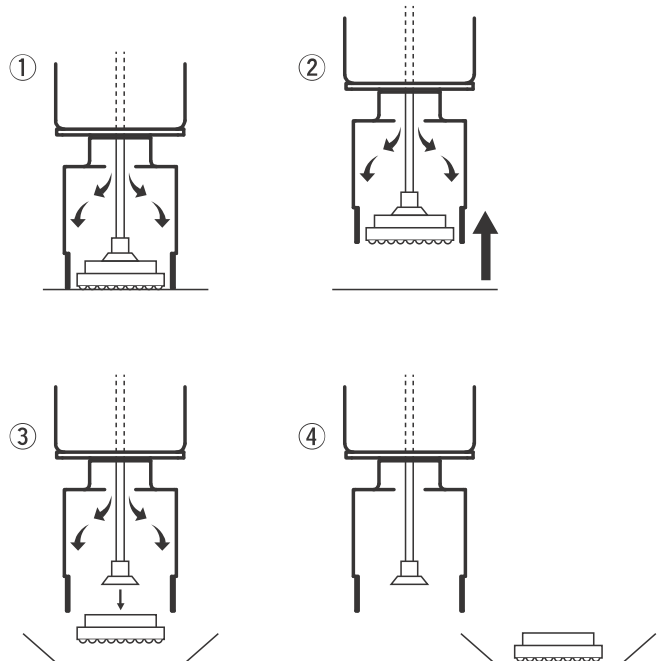

**⚠ CAUTION**  
Solder remaining on the P.W.B. (printed-wiring board) will be deteriorated. Use a solder sucker or wick to remove remaining solder.

Regarding settings, some settings can be performed directly from the top screen and some settings are performed by opening the menu screen.

### A. Mode selection

2 modes can be selected on the HAKKO FR-811 according to how it will be used. The screens are different for the different modes.

Example: MANUAL mode and AUTO mode display examples

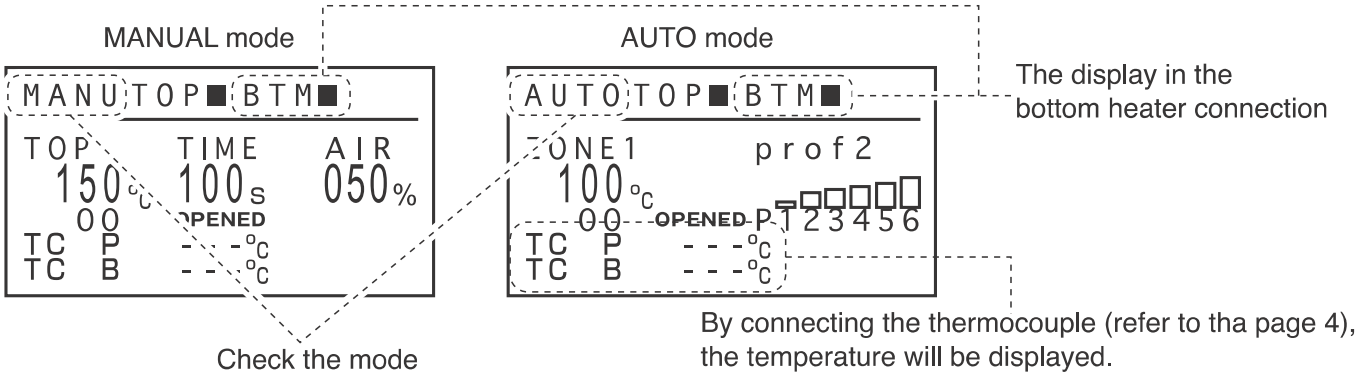

### ● Display during operation

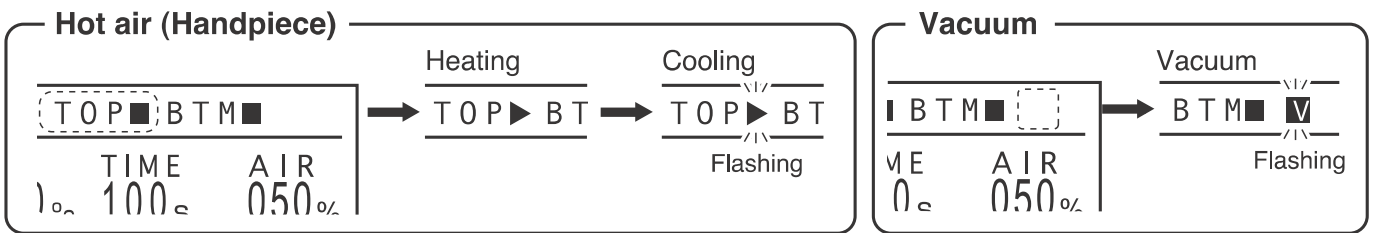

During bottom heater operation, [■] will be displayed to the right of BTM in the same way.

### ● Mode selection

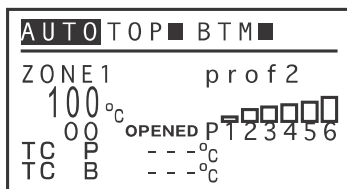

① In the top screen, turn the control knob to move the cursor to AUTO or MANU.

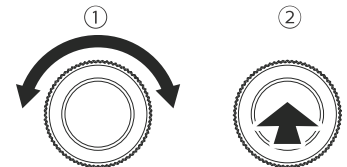

② After selecting, press the center of the control knob.

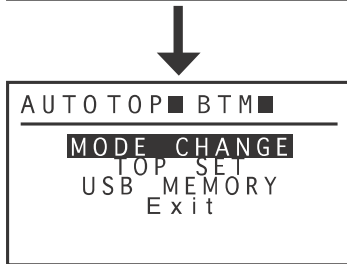

③ In the menu screen, turn the control knob to move the cursor to MODE CHANGE

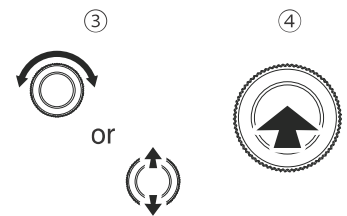

④ After selecting, press the center of the control knob.

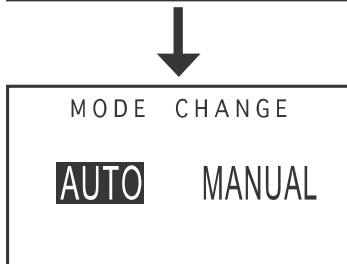

⑤ In the menu screen, turn the control knob to select AUTO or MANUAL.

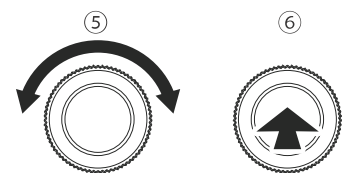

⑥ After selecting, press the center of the control knob. The display will return to the menu screen.

**⚠ CAUTION**  
When the HAKKO FR-811 is operating, mode change can not be performed.

## B. MANUAL mode settings

In the top screen, the cursor can be moved to the items for which settings can be changed by turning the control knob to the left or right. The items which can be set are as follows:

1. Menu screen (P.11)    4. Timer setting (P.12)    6. Airflow setting (P.12)

2. Temperature setting (P.12)    3. Offset temperature setting (P.12)    5. Timer mode selection (P.12)

● **Initial Value**

Set Temp	Air	Timer	RAMP	Timer mode
300°C	50%	---	--	Opened

※In the top screen, tilting the control knob up or down switches between the handpiece section and bottom heater section of the display screen.

**Note:**  
Switching cannot be performed in the middle of changing a setting.

### • Bottom heater display screen

Menu screen    Mode selection\*

\* The mode can be set to T/C mode in which the temperature of the circuit board is measured using a thermocouple or POWER mode in which output power is controlled.  
\*\* When POWER mode is selected, the setting becomes the output power.  
\*\*\* When T/C mode is selected, the startup rate can be set.

Temperature setting (output power setting\*\*)

Startup rate setting\*\*\*

※When pressing the S button (on the station) on the display screen of the bottom heater, bottom heater works / stop. (refer to the “● Connection method of the bottom heater” in page 42.)

## 1. Menu screen

In the menu screen, turning the operation knob left or right will move the cursor. If you move the cursor to the desired item and press the center of the operation knob, you can perform the settings for each item.

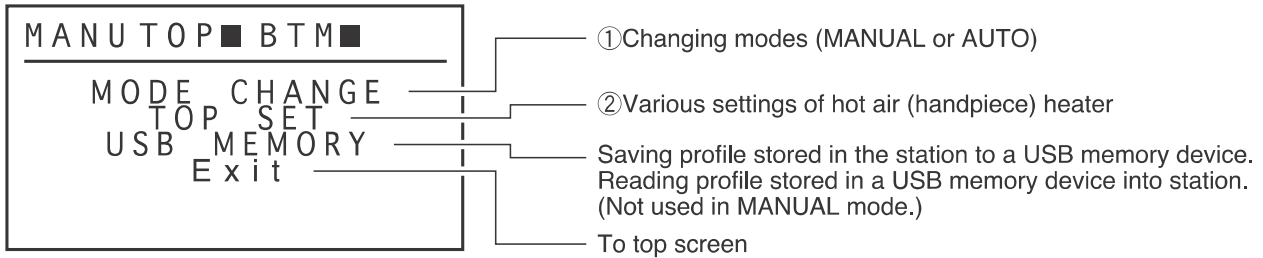

### ① Changing modes

Refer to the "● Mode selection" in page 9.

### ② Various settings of hot air (handpiece) heater

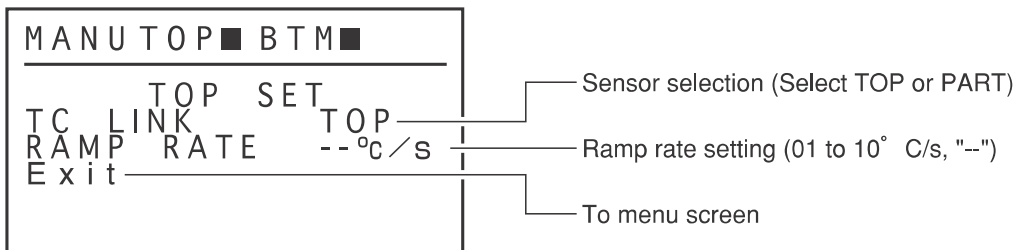

- Sensor selection (Select TOP or PART)

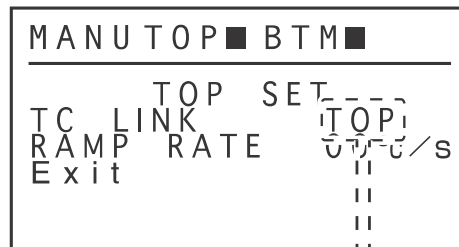

"L" will be displayed when "PART" is selected.

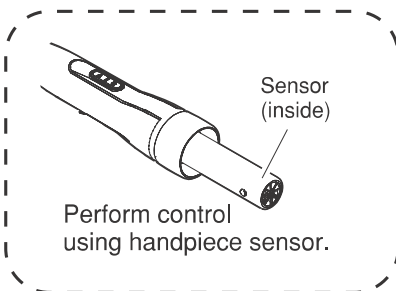

Select TOP.

Select PART.

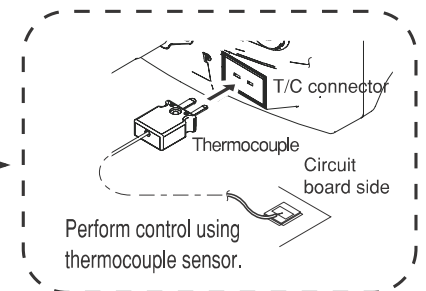

- RAMP RATE (rate of temperature rise) setting

The ramp rate of the startup temperature can be set to between 1°C and 10°C (per second).

Note:

When "--" is set, the ramp rate is not controlled and normal electrical power is applied.

### ⚠ CAUTION

Restrictions created by various nozzles may reduce the rate of temperature rise.

## 2. Setting the Temperature

The temperature range is from 50 to 600°C. (120 to 1120°F)

If you enter a value outside the temperature setting range, the display returns to the hundreds digit, and you have to enter a correct value.

### ※ Preset mode

In addition to the procedure described remove above, HAKKO FR-811 includes a preset mode allowing the selection of temperature from the options you define (up to 5 temperature settings can be programmed).

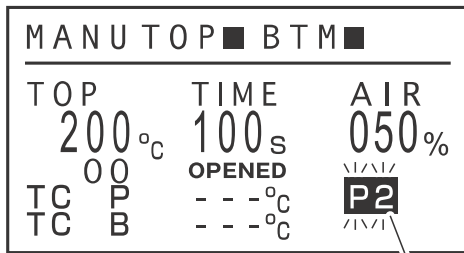

### ● Initial value

	Set Temp	Air	Timer	RAMP	Timer mode
PRESET1	100°C	50%	---	--	Opened
PRESET2	200°C	50%	---	--	Opened
PRESET3	300°C	50%	---	--	Opened
PRESET4	400°C	50%	---	--	Opened
PRESET5	500°C	50%	---	--	Opened

Select the preset number with

The procedure for making changes to the preset temperatures is the same as the "2. Setting the Temperature". Enter the parameter setting to change the mode. (refer to the "8. PARAMETER SETTING" in page 26.)

## 3. Offset temperature setting

Setting is available within the range of  $\pm 50^{\circ}\text{C}$  ( $90^{\circ}\text{F}$ )

### ⚠ CAUTION

If the total of a set value and an offset value exceeds  $600^{\circ}\text{C}$ , the exceeding portion in the offset value is not effective.

## 4. Timer setting

The timer range is from 001 to 999 sec and "---( $\infty$ )" .

## 5. Timer mode selection

Timer mode setting can be switched between the Opened timing and the Closed timing modes.

Opened timer

Count starts from the set temperature reached

Closed timer

Count start from energization

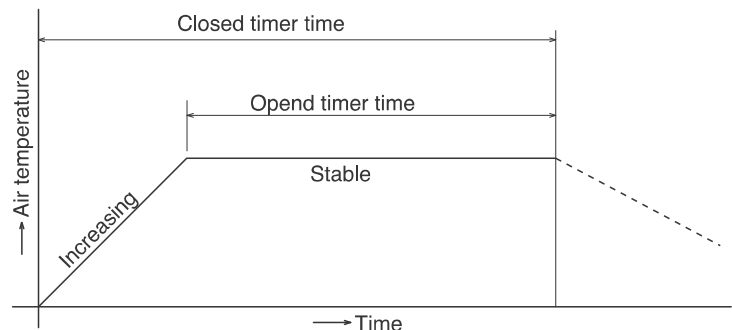

## 6. Airflow setting

The air flow setting range is 001 to 100 (%).

Set in the following operation



Selected position and the preset number

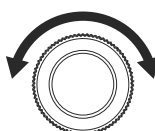

Changes values and the selected item



Enter

## C. AUTO mode settings

In the top screen, the cursor can be moved to the items for which settings can be changed by turning the operation knob to the left or right. The items which can be set are as follows:

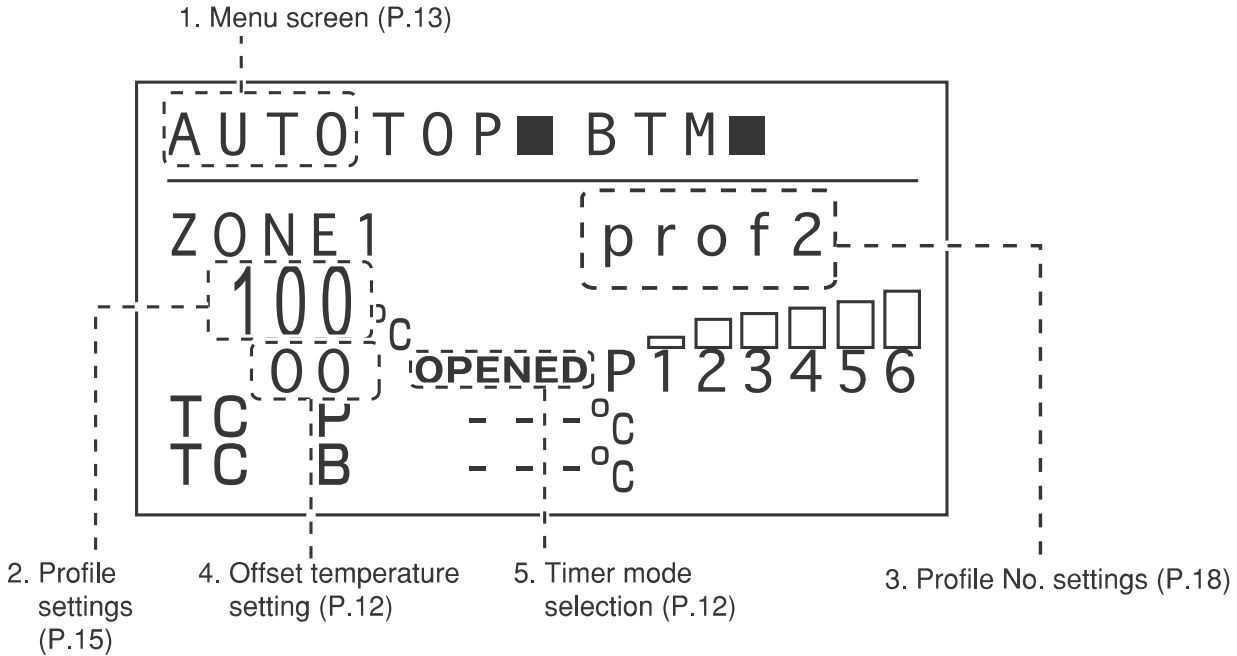

Set in the following operation

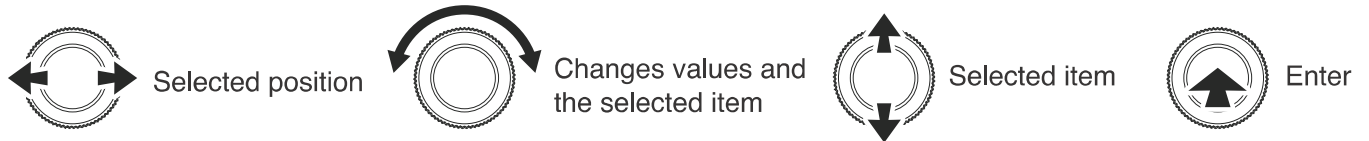

### 1. Menu screen

In the menu screen, turning the operation knob left or right will move the cursor. If you move the cursor to the desired item and press the center of the operation knob, you can perform the settings for each item.

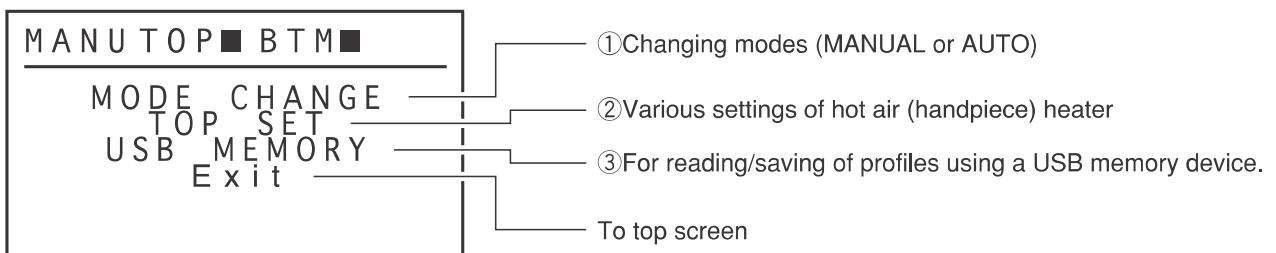

#### ① Changing modes

Refer to the "● Mode selection" in page 9.

#### ② Various settings of hot air (handpiece) heater

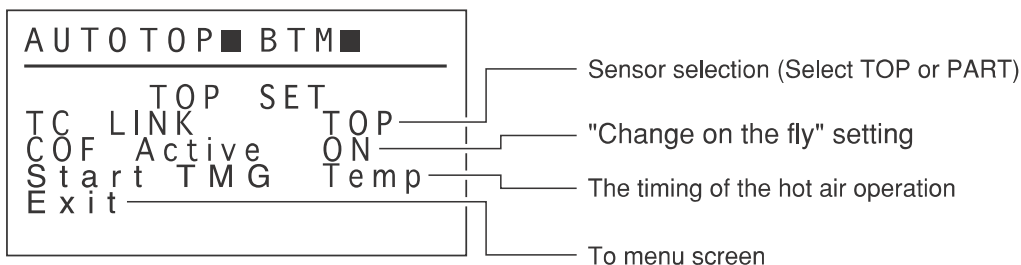

- Sensor selection (Select TOP or PART)  
Refer to the "Sensor selection" in page 11.

- "Change on the fly" setting  
Select ON or OFF for the "Change on the fly" function.

※Select ON for the "Change on the fly" function.

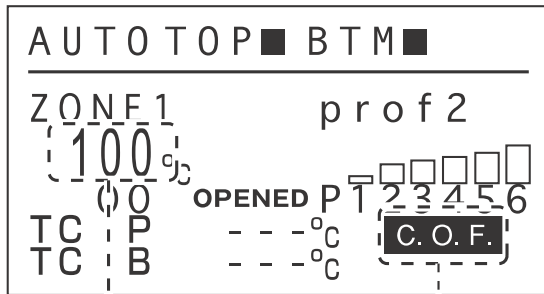

Changing value

Displayed when value is changed.

During operation, it will change the set temperature perform the following operation.

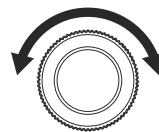

Changes values

The temperature range within which change can be performed is  $\pm 25^{\circ}\text{C}$  from the initial

After operation has been completed, whether or not to save the changed temperature setting will be checked. Select Y to save the changed temperature setting or N to not save it.

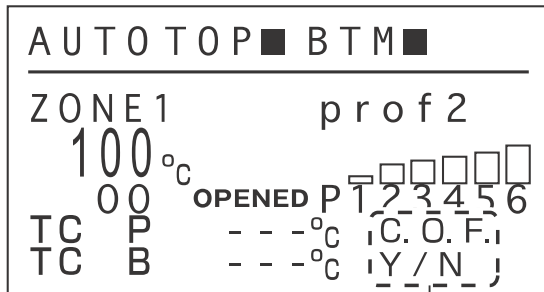

Save temperature check

Set in the following operation

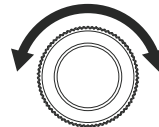

Select



Enter

**CAUTION**  
The current profile is overwritten.

※"Change on the fly" allows settings for each zone to be made and saved.  
For details, please refer to page 25.

- The timing of the hot air operation  
Set the timing for the operation of hot air.

Temp: Once the bottom heater reaches the set temperature hot air works.  
0 sec: Bottom heater and hot air will work at the same time.

※ When you select the POWER mode in PRE ZONE SET (refer to page 16), this setting is disabled.  
Operation examples, please refer to page 17.

③ Reading/saving of profile to USB memory device

Select reading a profile stored in the USB memory device or saving a profile to the USB memory device.  
(This item cannot be selected if there is no USB memory device plugged in.)

## 2. Profile settings

Pressing the center of the operation knob while the temperature is selected will change to the profile setting screen.

Turning to setting screen will be displayed below.

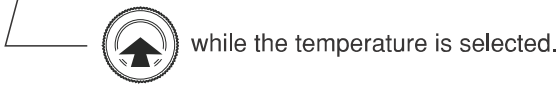
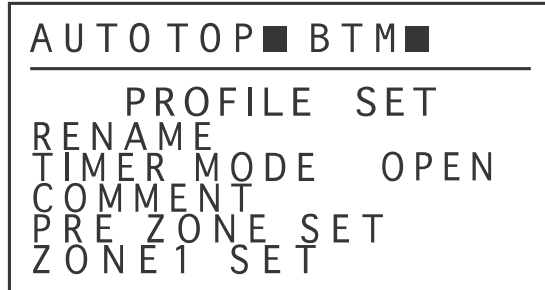
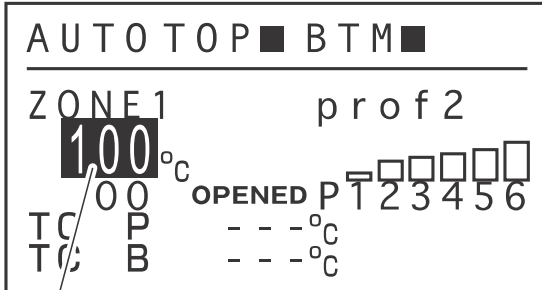

while the temperature is selected.

The following settings can be changed from this screen:

- ① RENAME — Input profile name.
- ② TIMER MODE — Select opened timer or closed timer.

● Initial Value	Timer mode
	Opened

- ③ COMMENT — Input comment.

- ④ PRE ZONE SET — Bottom heater settings

● Initial Value	ON / OFF	Mode	Power	Timer
PRE ZONE	OFF	POWER	50%	150sec.

- ⑤ ZONE 1 SET — Set Zone 1 settings.
- ⑥ ZONE 2 SET — Set Zone 2 settings.
- ⑦ ZONE 3 SET — Set Zone 3 settings.
- ⑧ ZONE 4 SET — Set Zone 4 settings.
- ⑨ ZONE 5 SET — Set Zone 5 settings.
- ⑩ ZONE 6 SET — Set Zone 6 settings.

● Initial Value	ON / OFF	Set Temp	Air	Timer	RAMP	Vacuum
ZONE1	ON	100°C	50%	10sec.	--	OFF
ZONE2	ON	200°C	50%	10sec.	--	OFF
ZONE3	ON	300°C	50%	10sec.	--	OFF
ZONE4	ON	400°C	50%	10sec.	--	OFF
ZONE5	ON	500°C	50%	10sec.	--	OFF
ZONE6	ON	600°C	50%	10sec.	--	OFF

- ⑪ DEMO MODE — Read sample data for demo mode.
- ⑫ PROFILE COPY — Copy a desired profile to another profile.
- <EXIT> — To top screen.

Set in the following operation



or

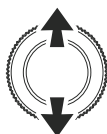

Changes the selected item



Enter



① **RENAME (Input profile name.)**

Up to 10 characters can be input for the profile name. The characters that can be input are ASCII characters (without “,” ). If you select the " ? " after the character will disappear.

② **TIMER MODE (Change of countdown method.)**

Timer mode setting can be switched between the Opened timing and the Closed timing modes.

③ **COMMENT (Input comment.)**

Up to 100 characters can be input for the profile name. The characters that can be input are ASCII characters (without “,” ). If you select the " ? " after the character will disappear.

④ **PRE ZONE SET (Setting bottom heater settings.)**

The various settings of the bottom heater can be performed.  
First, select whether the bottom heater function will be ON or OFF.

- When ON is selected:

When ON is selected, the following settings can be performed.

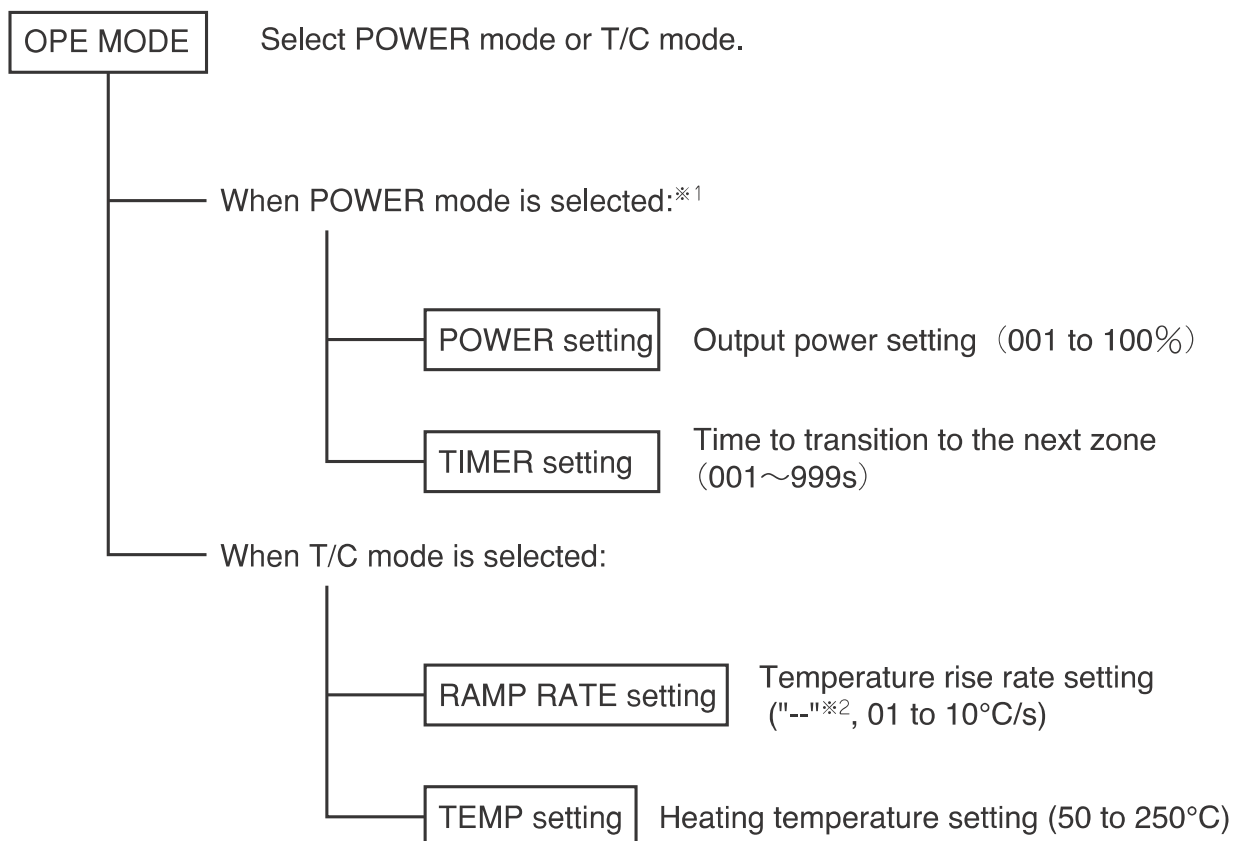

※1 When selecting the POWER mode, the setting of the START TMG (refer to page 14) is disabled.

※2 When "--" is set, the ramp rate is not controlled and normal electrical power is applied.

When selecting the AUTO mode, bottom heater will operate until the profile is completed.

Example :

POWER mode

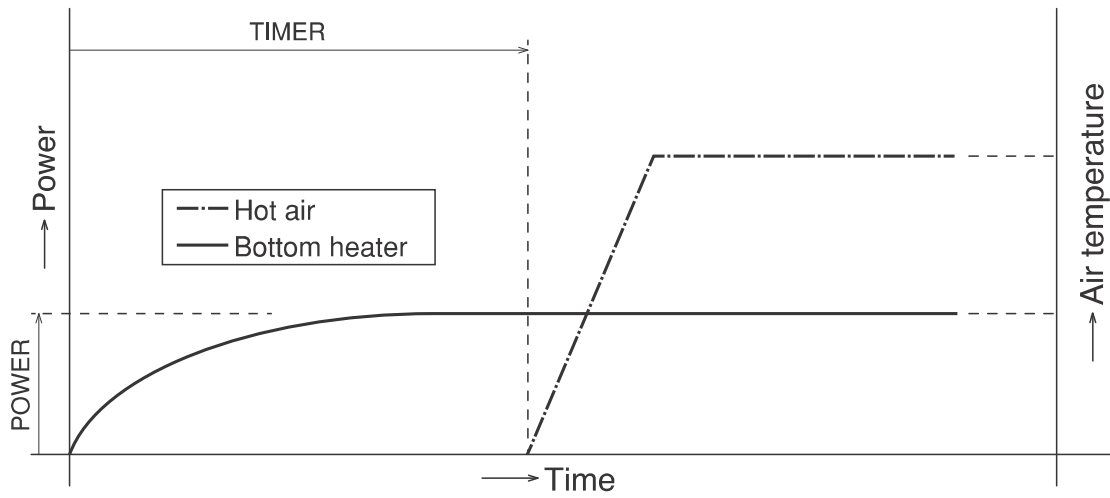

T/C mode (START TMG : Selected "TEMP" ) T/C mode (START TMG : Selected "0sec" )

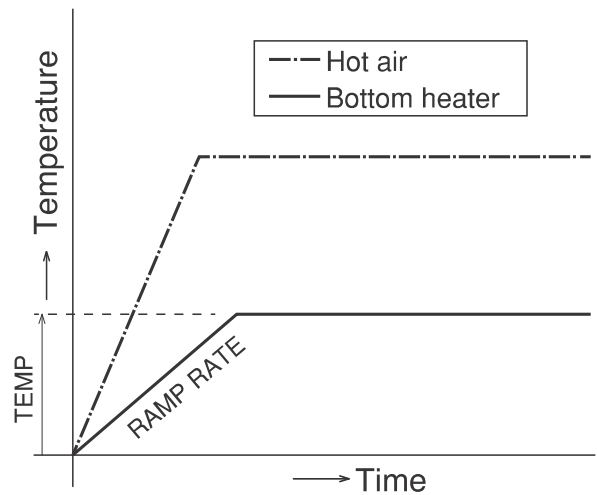
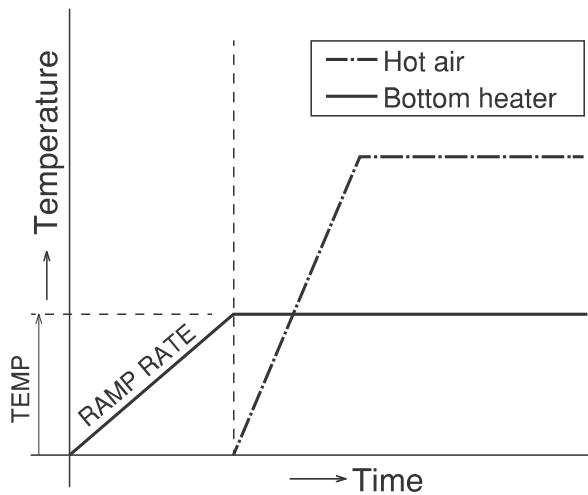

**⚠ CAUTION**

When the setting is not connected to the bottom heater in a state of ON, HAKKO FR-811 will not operate.

---

## ⑤ ZONE 1 SET (Setting ZONE1)



## ⑩ ZONE 6 SET (Setting ZONE6)

The hot air setting is performed. The same items can be set for each zone. First, select whether the selected zone function will be ON or OFF.

### • When ON is selected:

When ON is selected, the following settings can be performed.

#### **RAMP RATE setting**

Temperature rise rate setting ("--"\*, 01 to 10°C/s)

#### **Setting the Temperature**

Heating temperature setting (50 to 600°C)

#### **Setting the Timer**

Heating time setting (001 to 999s)

#### **Setting of the air flow**

Airflow rate setting (001 to 100%)

#### **Vacuum setting**

Vacuum function ON/OFF setting (ON/OFF)

\* When "--" is set, the ramp rate is not controlled and normal electrical power is applied.

#### **⚠ CAUTION**

If you enter a value outside the temperature setting range, the display returns to the state of setting wait again.

## ⑪ DEMO MODE (Read the sample data for the demo)

Simple settings for the demo, which is built-in to the station will be loaded.

## ⑫ PROFILE COPY (Copy any profile data to another profile)

Copy any profile data to another profile.

### 3. Profile number setting

Select the place of the profile name, you can make the selection of profile No. Turn the control knob.

### 4. Offset temperature setting

Please refer to the “3. Offset temperature setting” in page 12.

### 5. Timer mode selection

Please refer to the “5. Timer mode selection” in page 12.

# 7. CONNECTION WITH PC

---

When you connect the HAKKO FR-811 and the PC, you can transfer the profile data to each other.

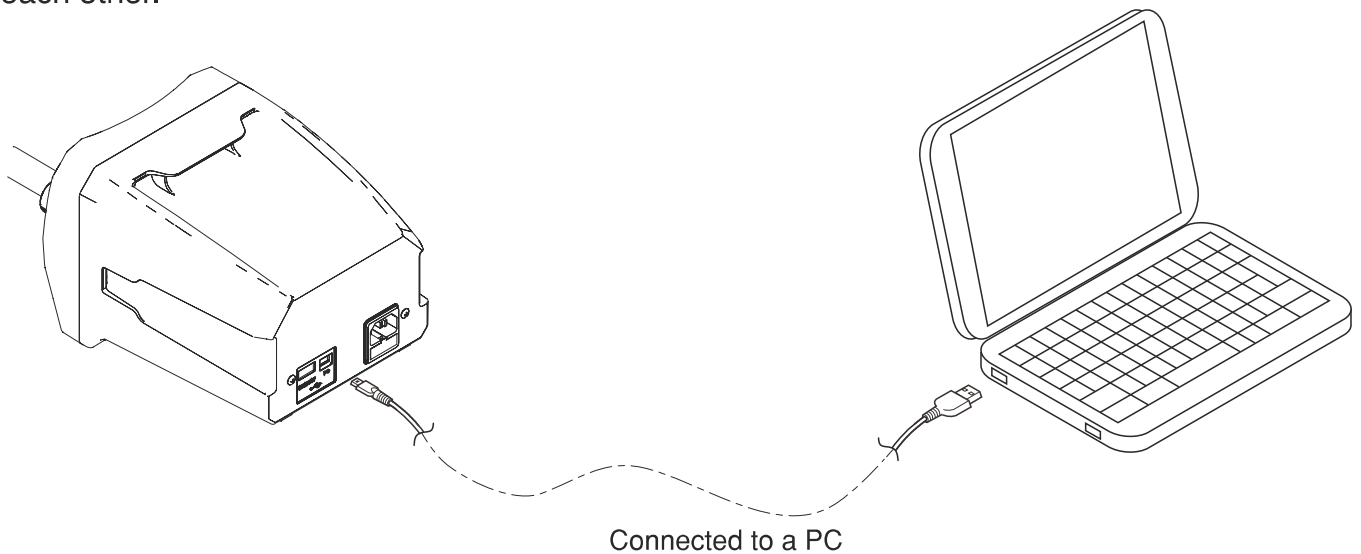

## ● Confirmed operating environment

The operation of the accompanying software has been confirmed in the following environment:

OS : Windows 7 / 8.1

Microsoft .Net Framework 4.5 or higher

## ● Installing driver

When connecting the HAKKO FR-811 to a PC, it is necessary to install the driver. Follow the procedure below to install the driver.

### ⚠ CAUTION

You must be logged in with Administrator rights to install the driver.

1. Connect the HAKKO FR-811 to the PC using the included cable, and turn the power switch of the HAKKO FR-811 ON.
2. Installation will start, but it will not be able to be completed normally.
3. Right-click on "CENTE" in "Other devices" on Control Panel > Hardware and Sound > Device Manager to open the right-click menu and click on "Update driver software".
4. Select "Browse my computer for driver software".
5. Select the included CD as the browse destination.
6. Select "Install this driver software".
7. After a short while the installation will be completed and "HAKKO USB Device" will be added to the Device Manager.

## ● Preparing to use the PC software

The HAKKO FR-811 PC Software was created using Visual Studio 2013 C++. If the Visual Studio 2013 C++ runtime is not installed on the computer, the software will not run properly. Install the runtime according to the procedure below.

1. Run "**vc redistrib\_x86.exe**" on the included CD.
2. Put a check in the checkbox and click "Install".
3. Wait until the installation is complete.

※Installer of Microsoft Visual studio 2013 C ++ included in the supplied CD-ROM will be displayed in English. If you want to other language, select the language in the following website, please download the file.

- Visual C++ Redistributable Packages for Visual Studio 2013

Microsoft web site : <http://www.microsoft.com/>

After downloading the file, run "**vc redistrib\_x86.exe**".

## ● Using the PC Software

Copy the HAKKO FR-811 PC Software file "**FR811\_PCSoftware.exe**" to any folder on your computer. When FR811\_PCSoftware is run for the first time, a "Files" folder will be created in the same folder as the software. FR811\_PCSoftware will store graph data, etc. in the "Files" folder. PCSoftware can be used according to the following procedure.

1. Ensure that the device is connected with the PC using a USB cable, and turn the power switch ON of HAKKO FR-811.
2. "P" is displayed on the monitor the lower right corner of the HAKKO FR-811.

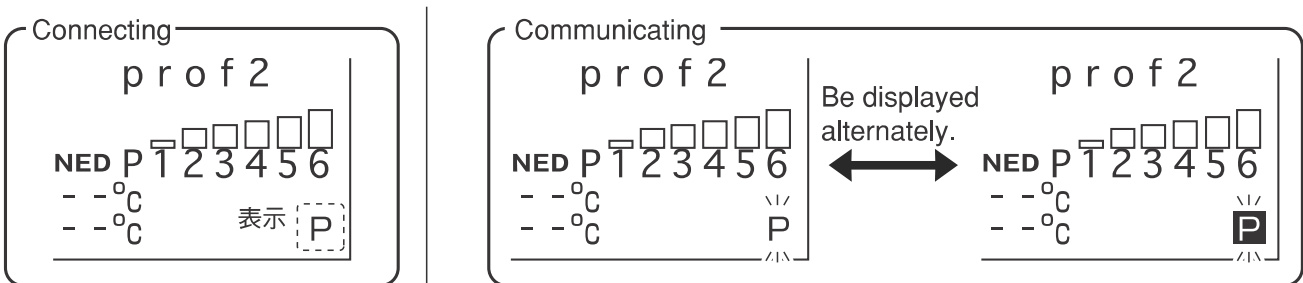

### ⚠ CAUTION

When the "P" does not appear, it is not connected properly, or driver software might not have been installed correctly.

3. Double click the software "**FR811\_PCSoftware.exe**" and start it.

## ● Setting and operation screen

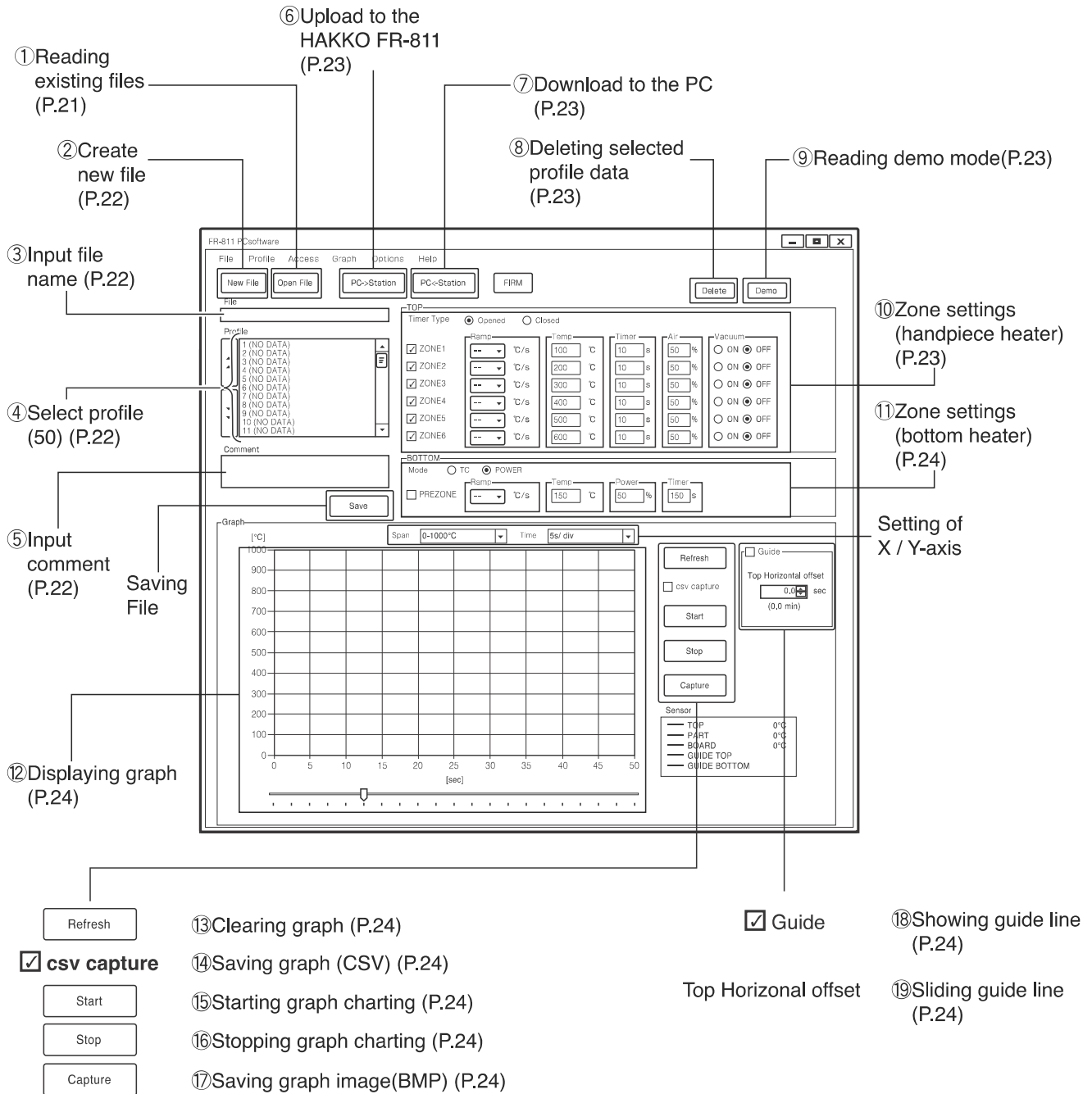

### A. Setting

#### ① Reading existing files

Files stored on a PC can be opened. A single file can contain up to a maximum of 50 profiles.

#### ⚠ CAUTION

All currently open profile data on the PC will be overwritten. Be careful not to delete profiles that you need.

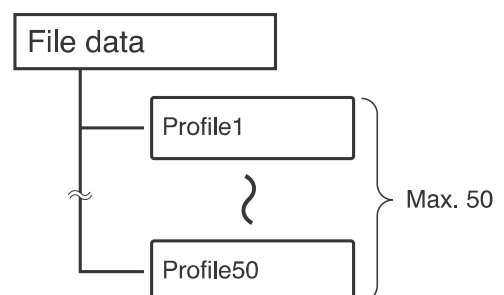

## ② Create new file

Creates a new file. The software will ask whether to save the current profile. Select  to save it or  to not save it.

## ③ Input file name

Input the name of the file to create. Characters which can be input are ASCII characters other than ".".

## ④ Select profile

Select the profile for which you want to perform settings from among the profiles in the created file.

### \*Create a new file

1. Select profile and double click it.

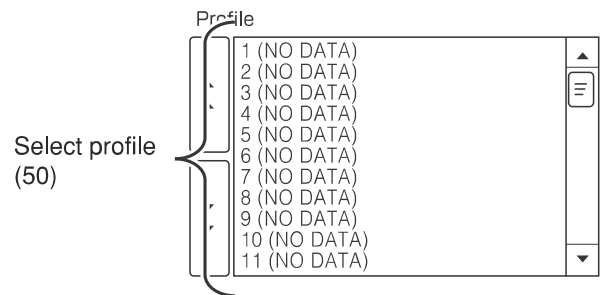

2. Enter the new profile name. Click the  button once more to complete the procedure.

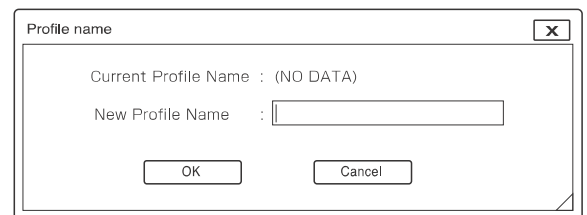

3. A new profile data is created. Change settings as needed.

For the items which can be changed see ⑩ "Zone settings (soldering iron heater)" on p. 23 or ⑪ "Zone settings (bottom heater)" on p. 24.

## ⑤ Input comment

Up to a maximum of 100 characters can be input for the comment. Characters which can be input are ASCII characters other than ".".

### Example) How to name a file or profile

Input the board name for the file name and the part name for the profile name.

This allows easy understanding of which board the selected file is for and which part the profile is for.

If the conditions during operation, caution items, etc. are input as the comment, errors can be prevented.

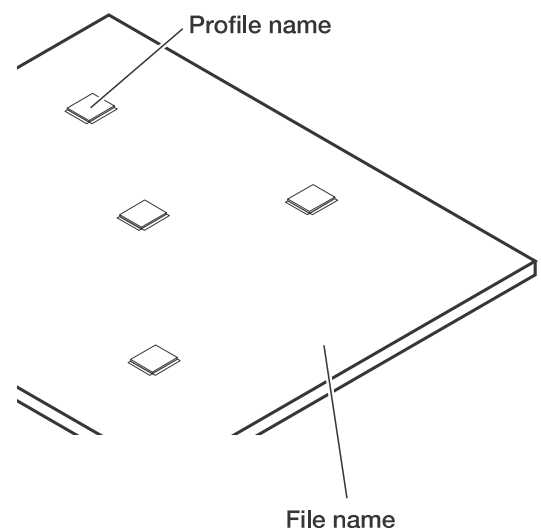

⑥ Upload to the HAKKO FR-811

1. To upload created profile data to the HAKKO FR-811, click  .

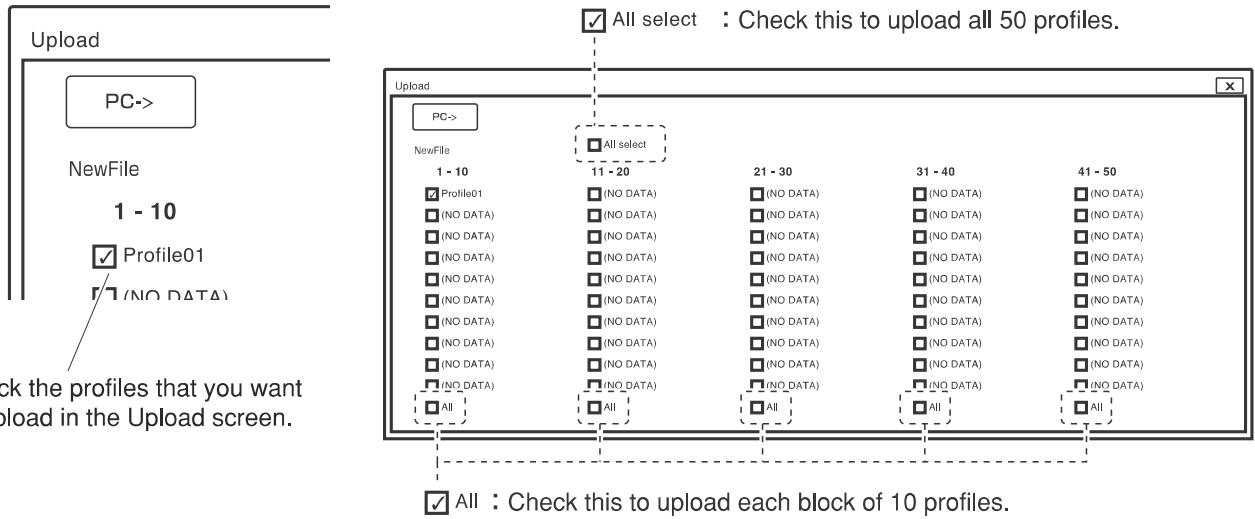

Check the profiles that you want to upload in the Upload screen.

2. Click  to upload the data.

⑦ Download to the PC

1. To download profile data to the PC, click  .

2. Click  to upload the data.

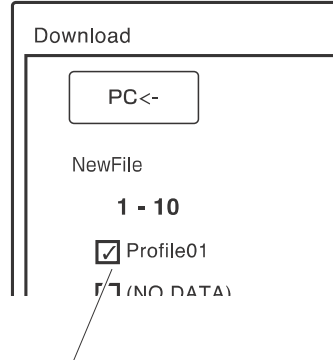

Check the profiles that you want to download in the download screen.

**CAUTION**  
When uploading is performed in steps ⑥ and ⑦, all destination profile data will be overwritten. Be sure to take measures such as previously saving necessary profile data, etc. to avoid overwriting necessary profile data by mistake.

⑧ Deleting selected profile data.

To clear the currently selected profiles, click  .

⑨ Reading demo mode

To read the internal profiles (select from 3 types), click  .

⑩ Zone settings (soldering iron heater)

You can set the items listed below for ZONE1 to ZONE6. For conditions such as setting ranges, etc., please refer to page 18.

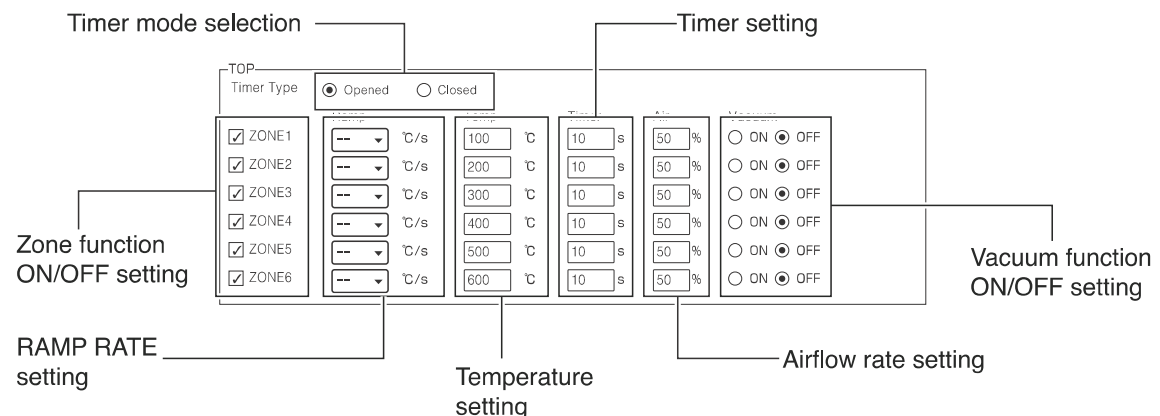



⑪ Zone settings (bottom heater)

The following settings for the bottom heater can be set.

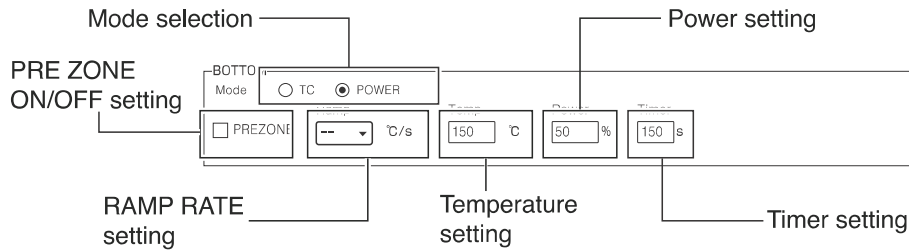

In T/C mode, you can set the RAMP RATE and temperature; in POWER mode you can set the Power and Timer. For conditions such as setting ranges, etc., please refer to page 16.

⑫ Displaying graph

During operation, the actual temperature data will be shown on the graph.

**B. Operation**

⑬ Clearing graph

To clear the displayed graph, click  .

⑭ Saving graph (CSV)

If  **csv capture** is checked previously, the graph can be saved in CSV format.

⑮ Starting graph charting

To start graph charting, click  .

**⚠ CAUTION**  
 If the profile set in the PC is not uploaded to the HAKKO FR-811, the actual operation will not be shown. Follow the instructions in ⑥ "Uploading PC profile to station" on page 23 to upload data to the station.

⑯ Stopping graph charting

To stop graph charting, click  . If  **csv capture** is checked, the software will ask whether to save the data at this time in CSV format.

⑰ Saving graph image (BMP)

To save an image (bmp) of the displayed graph, click  .

⑱ Showing guide line

If  **Guide** is checked, the current setting will be shown on the graph.

⑲ Sliding guide line

To slide the Guide line to the set time, move the slider.

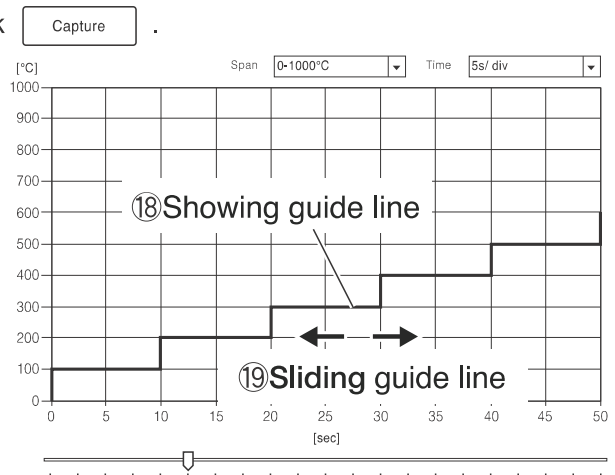

※ Example of using C.O.F. (Change on the fly)

1. Select "PART" in "Sensor selection" (refer to page 11), and attach the thermocouple to the part.

2. Look up the temperature conditions for removing the part and perform profile settings.

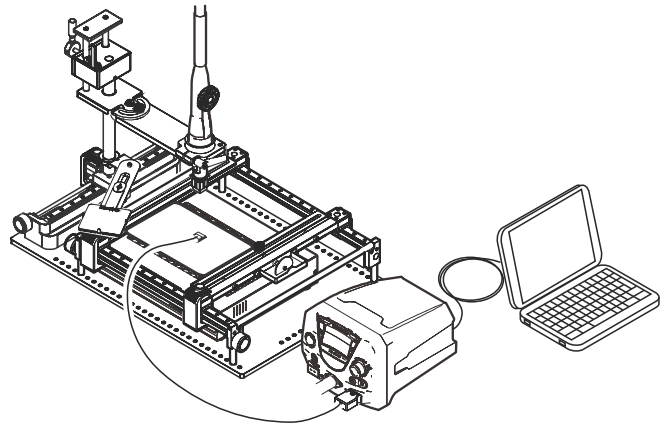
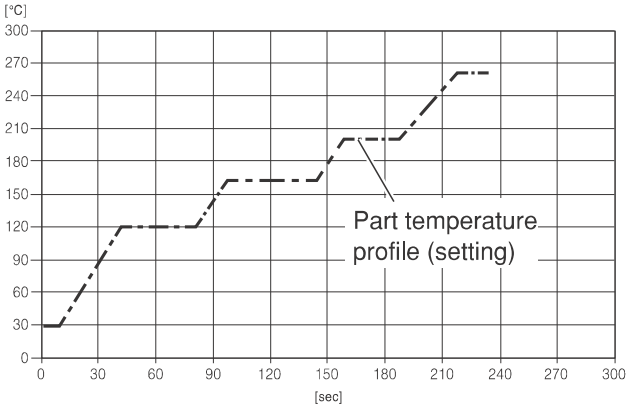

3. When removal is performed according to the settings, the temperature graphs for both the part and the soldering iron heater will be shown as shown at left below. Select "TOP" in "Sensor selection" and set the profile from the heater temperature graph.

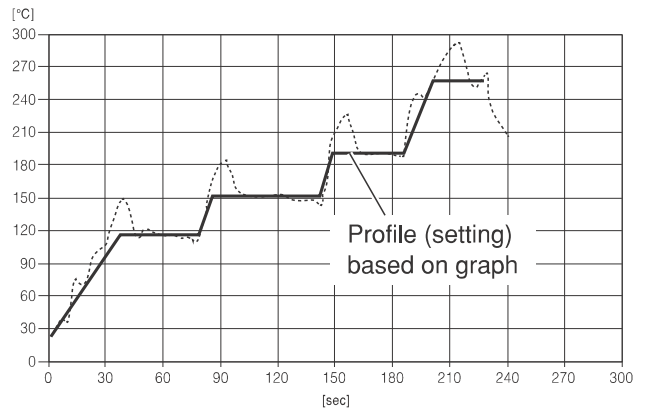
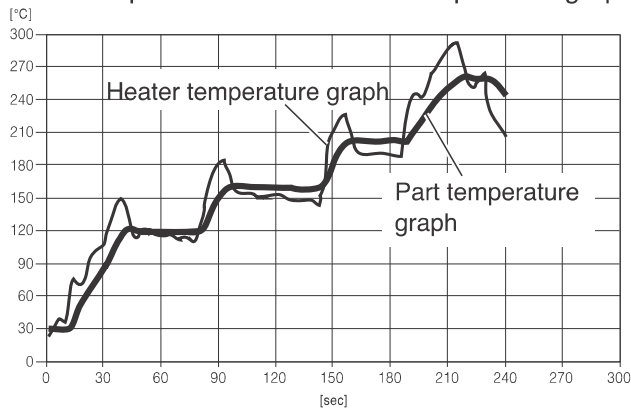

4. Prepare a different board and remove the same part using the profile set in step 3. If the actual measured value is different than the expected temperature, use "C.O.F." to change the set temperature for each ZONE. (please refer to page 14 for changing settings.)

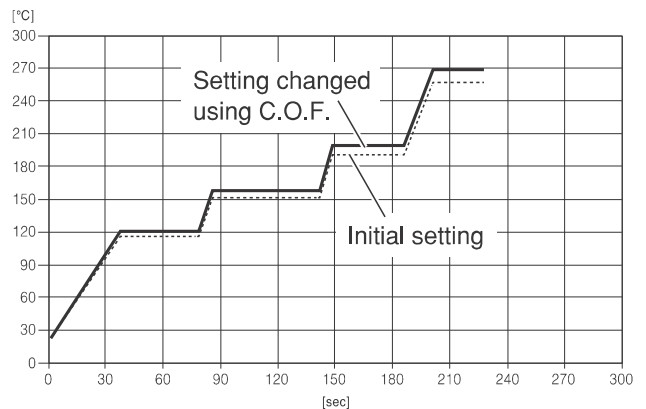
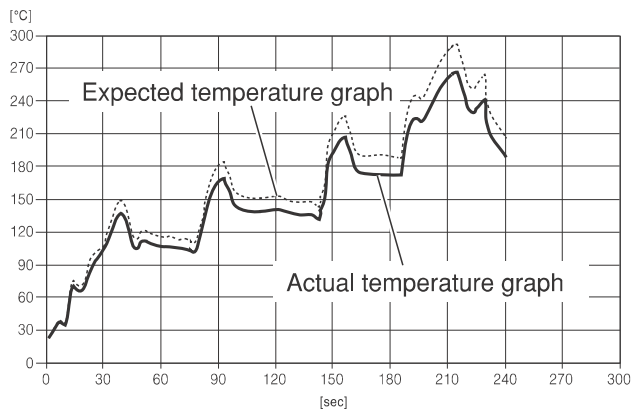

5. The changed profile can be used to remove parts from boards under the same conditions from then on.

# 8. PARAMETER SETTING

## ● Parameter settings

The HAKKO FR-811 has the following parameters:

Parameter settings table

Parameter name	Value	Initial value
Temp Mode	°C / °F	°C
Sleep	OFF / ON	ON
ShutOff Set	---, 30~60 min	30 min
Air ShutOff	OFF / ON	OFF
PRESET	OFF / ON	OFF
PRESET MAX. number *	2 - 5 pcs.	-
TC B Alert	- -, 01~30 min	- -
Lock Mode	ON / CUSTOM / OFF **	OFF
TEMP SET ***	LOCK / FREE	-
SEL PRESET ***	LOCK / FREE	-
OFFSET SET ***	LOCK / FREE	-
FLOW SET ***	LOCK / FREE	-
TIMER SET ***	LOCK / FREE	-
RAMP SET ***	LOCK / FREE	-
PROFILE SET ***	LOCK / FREE	-
SEL PROFILE ***	LOCK / FREE	-
MODE CHANGE ***	LOCK / FREE	-
USB OPE ***	LOCK / FREE	-
Date & Time	Date setting	
Contrast	-05 ~ +05	00
Initial Reset	Partial / All / Cancel	-

\* "ON" is selected.

\*\* ON : You can not make changes without entering a password.

CUSTOM : You can choose whether or not a password is needed to make changes.

OFF : You can make changes without entering a password

\*\*\* "CUSTOM" is selected.

Press and hold the control knob while turning on the power switch.

Parameter setting screen

System Parameter	
Temp Mode	°C
Sleep	ON
Shut Off	30 m
Air Shut Off	OFF
Preset	OFF
TC B Alert	---

---

## ● Temp Mode

The displayed temperature can be switched between Celsius and Fahrenheit.

## ● Sleep

Select whether you will activate the auto sleep function.

## ● ShutOff Set

Set auto shutoff time.

## ● Air ShutOff

Specify whether or not to enable the function that allows you to force the termination of cooling after completion of work. Forced termination in high temperature may cause premature failure of the heating element. Do not use the function except for work in low temperature.

## ● Preset

Temperature setting can be switched between the normal mode and the preset mode.

If selecting the preset mode, you will be asked for the number of preset to have available for programming.

## ● TC B Alert

Turns on the TC B alert to stop heater control if the temperature fails to reach the predetermined level after a specific period of time following the start of control.

The heater power alert function will not operate if the timer is set to "- - -".

## ● Lock Mode

Select "ON", "CUSTOM" or "OFF" for password setting. If selecting the "ON", perform the setting for password. If selecting the "CUSTOM", choose whether or not the password function is needed when moving to the various setting modes and set the password.

The following settings can choose a password :

TEMP SET	(Heating temperature setting)
SEL PRESET	(Selecting the preset number)
OFFSET SET	(Offset temperature setting)
FLOW SET	(Airflow setting)
TIMER SET	(Timer setting)
RAMP SET	(Temperature rise rate setting)
PROFILE SET	(Profile settings)
SEL PROFILE	(Selection of profile)
MODE CHANGE	(Changing modes)
USB OPE	(Reading/saving of profile to USB memory device)

## ● Date & Time

Setting of the date & time.

## ● Contrast

To make the screen display easy to see, adjust contrast.

## ● Initial Reset

Return the set to the initial state. Partial returns a setting other than Profile to the initial state.

## ● Temp Mode

1. Turn the control knob, select "Temp Mode".



2. After selecting, press the center of the control knob.



3. °C and °F will be switched alternately.



4. After selecting, press the center of the control knob.



System Parameter	
Temp Mode	°C
Sleep	ON
Shut Off	30m
Air Shut Off	OFF
Preset	OFF
TC B Alert	---



Temperature Mode Set	
°C	°F

## ● Sleep

1. Turn the control knob, select "Sleep".



2. After selecting, press the center of the control knob.



3. ON and OFF will be switched alternately.

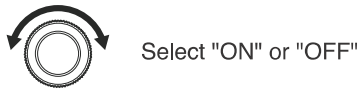

4. After selecting, press the center of the control knob.



System Parameter	
Temp Mode	ON
Sleep	ON
Shut Off	OFF
Air Shut Off	OFF
Preset	OFF
TC B Alert	---



System Parameter	
Temp Mode	OFF
Sleep	OFF
Shut Off	OFF
Air Shut Off	OFF
Preset	OFF
TC B Alert	---

## ● ShutOff Set

1. Turn the control knob, select "Shut Off".



2. After selecting, press the center of the control knob.



3. Set the time of the shut-off.  
(The shutoff set function will not operate if the timer is set to "--".)



4. After setting, press the center of the control knob.



System Parameter	
Temp Mode	°C
Sleep	ON
Shut Off	30m
Air Shut Off	OFF
Preset	OFF
TC B Alert	---

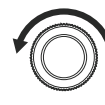

System Parameter	
Temp Mode	°C
Sleep	ON
Shut Off	--
Air Shut Off	OFF
Preset	OFF
TC B Alert	---



System Parameter	
Temp Mode	°C
Sleep	ON
Shut Off	60m
Air Shut Off	OFF
Preset	OFF
TC B Alert	---

## ● Air ShutOff

1. Turn the control knob, select "Air ShutOff".



2. After selecting, press the center of the control knob.



3. ON and OFF will be switched alternately.

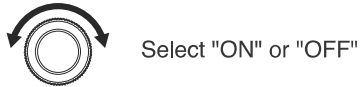

4. After selecting, press the center of the control knob.



System Parameter	
Temp Mode	°C
Sleep	ON
Shut Of	MIN/MAX
<b>Air Shut Off</b>	<b>OFF</b>
Preset	MIN/MAX
TC B Alert	---



System Parameter	
Temp Mode	°C
Sleep	ON
Shut Of	MIN/MAX
<b>Air Shut Off</b>	<b>ON</b>
Preset	MIN/MAX
TC B Alert	---

## ● Preset

1. Turn the control knob, select "Preset".



2. After selecting, press the center of the control knob.



3. ON and OFF will be switched alternately.

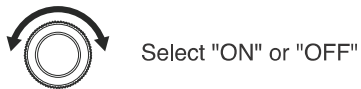

4. After selecting, press the center of the control knob.



System Parameter	
Temp Mode	°C
Sleep	ON
Shut Of	30m
Air Shut Off	MIN/MAX
<b>Preset</b>	<b>OFF</b>
TC B Alert	MIN/MAX



Preset	
<b>OFF</b>	ON



Select  
"ON"

Preset Max Num.
<b>5</b>

※When selecting "ON"

5. If selecting the preset mode, you will be asked for the number of preset to have available for programming.

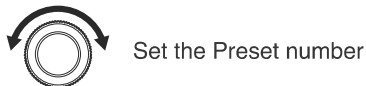

6. After setting, press the center of the control knob.



## ● TC B Alert

1. Turn the control knob, select "TC B Alert".



2. After selecting, press the center of the control knob.



3. Set the time of the TC B Alert.  
(The TC B Alert function will not operate if the timer is set to "--".)



4. After setting, press the center of the control knob.



System Parameter	
Temp Mode	°C
Sleep	ON
Shut Off	30m
Air Shut Off	OFF
Preset	MAX
<b>TC B Alert</b>	<b>--</b>



System Parameter	
Temp Mode	°C
Sleep	ON
Shut Off	30m
Air Shut Off	OFF
Preset	MAX
<b>TC B Alert</b>	<b>30m</b>

## ● Lock Mode

1. Turn the control knob, select "Lock Mode".



2. After selecting, press the center of the control knob.



3. Set the Lock Mode.

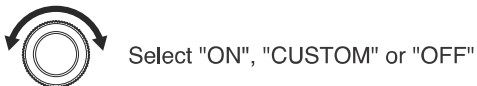

4. After setting, press the center of the control knob.



System Parameter	
TC B Alert	MAX
<b>Lock Mode</b>	<b>OFF</b>
Date & Time	MAX
Contrast	05
Initial Reset	
Exit	



Password Lock Setting		
ON	CUSTOM	<b>OFF</b>

(When selecting the "CUSTOM" or "ON", please refer to page 32)



※1 When selecting "CUSTOM":

5. Select the item you want to change the settings.



6. After selecting, press the center of the control knob.



7. Lock and Free will be switched alternately.

If you select Lock, you will need to enter the password when moving to the setting screen.

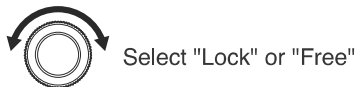

8. Select the "Exit" after setting, press the center of the control knob.



※2 When select "ON". (After setting "CUSTOM") :

9. Enter the password.

Select and input three letters for password from six letters (A - F).



10. After selecting, then move to the next character.

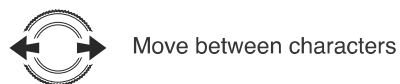

11. Select a character.



12. After selecting, then move to the next character.

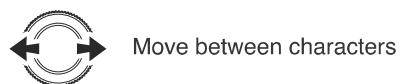

13. Select a character.



14. After setting, press the center of the control knob.

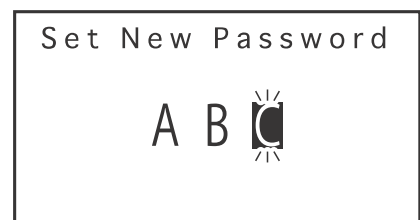
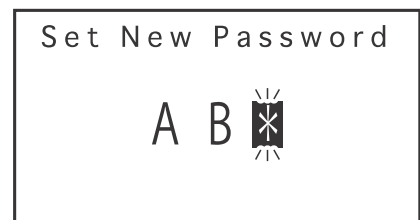
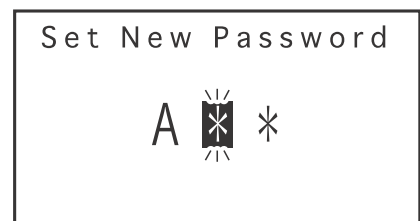
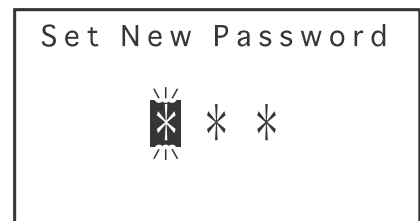
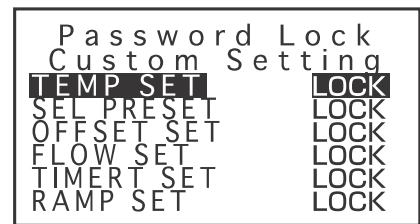

## ● Date & Time

1. Turn the control knob, select "Date & Time".



2. After selecting, press the center of the control knob.



3. Setting of the date & time.



4. After setting, press the center of the control knob.



System Parameter	
TC B Alert	---
Lock Mode	ON
Password	
<b>Date &amp; Time</b>	
Contrast	05
Initial Reset	



Set Date and Time	
2016/01/01/00:00	

## ● Contrast

1. Turn the control knob, select "Contrast".



2. After selecting, press the center of the control knob.



3. Adjust contrast.



4. After setting, press the center of the control knob.



System Parameter	
TC B Alert	---
Lock Mode	ON
Password	
Date & Time	
<b>Contrast</b>	05
Initial Reset	



LCD Contrast	
05	

## ● Initial Reset

1. Turn the control knob, select "Initial Reset".



2. After selecting, press the center of the control knob.



3. Select "PARTIAL" or "ALL".  
When you do not perform the initial reset,  
select "CANCEL".

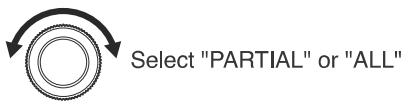

4. After setting, press the center of the control knob.



System Parameter	
TC B Alert	---
Lock Mode	ON
Password	
Date & Time	
Contrast	05
<b>Initial Reset</b>	



Initial Reset	
PARTIAL	<b>ALL</b>
CANCEL	

# 9. TEMPERATURE DISTRIBUTION CHART

## ⚠ CAUTION

- These charts do not define the temperature characteristics, and are for reference only.
- The temperature distribution charts for HAKKO 850 or 850B should not be used for HAKKO FR-811. HAKKO FR-811 uses a different pump and control system. When you use the HAKKO FR-811, make sure to refer to the temperature distribution charts shown to the under.
- The hot air temperature may not reach the set temperature depending upon the combination of the nozzle and the set air flow. In this case, reduce the set temperature or the air flow.

- Test condition: Measured at a point 1mm (0.04 in.) from the nozzle by recorder.

**HAKKO FR-811 Airflow**

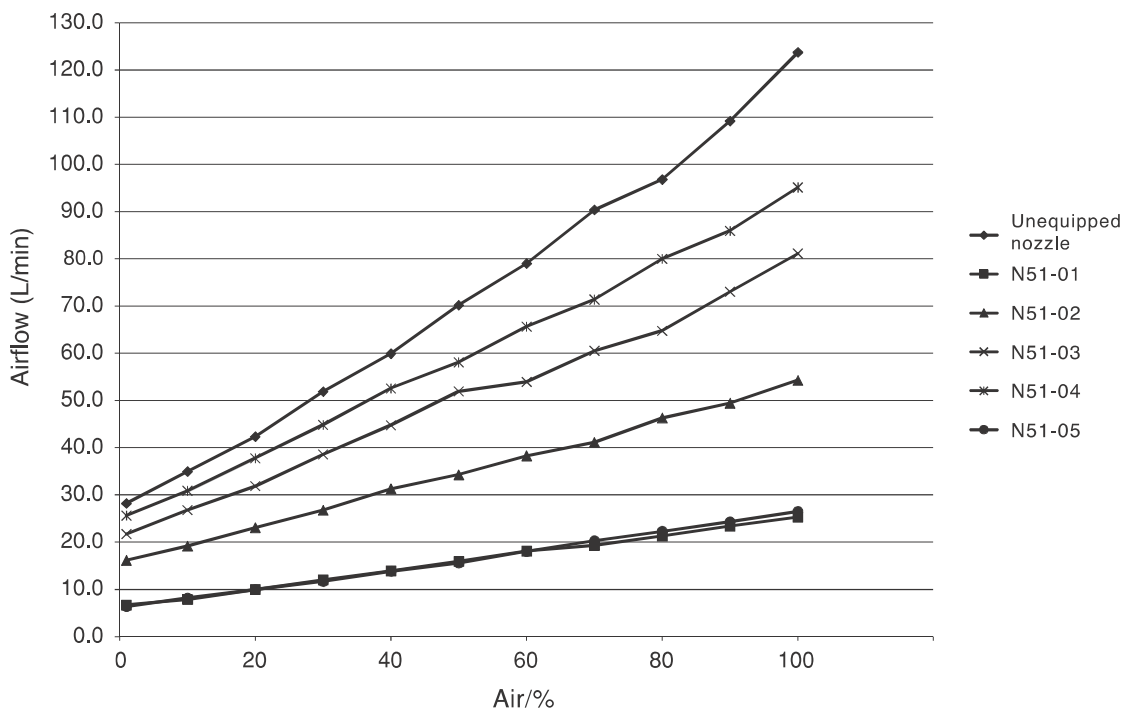

**N51-01 Single  $\phi$ 2.5 (0.10)**

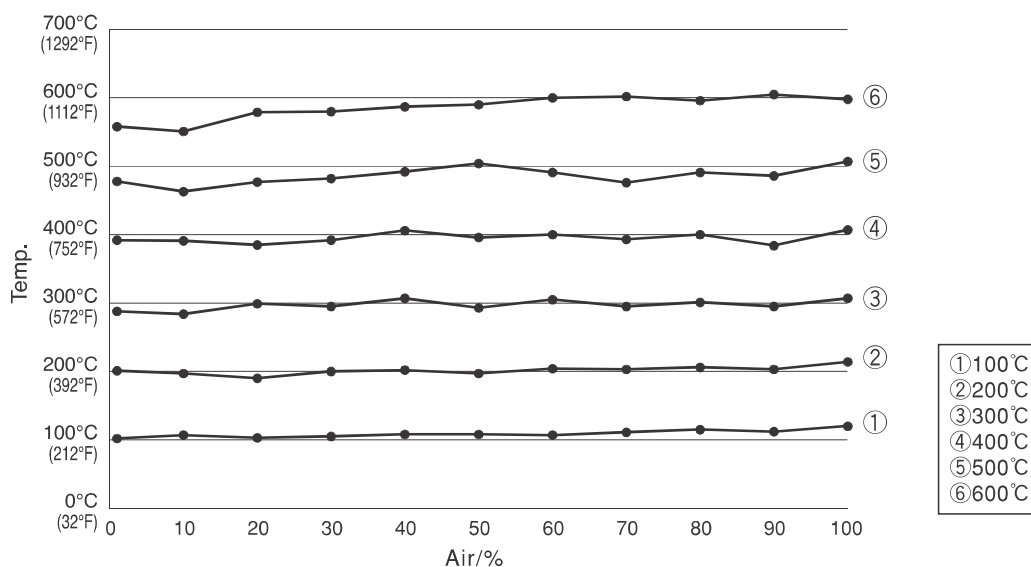

**N51-02 Single  $\phi$ 4.0 (0.16)**

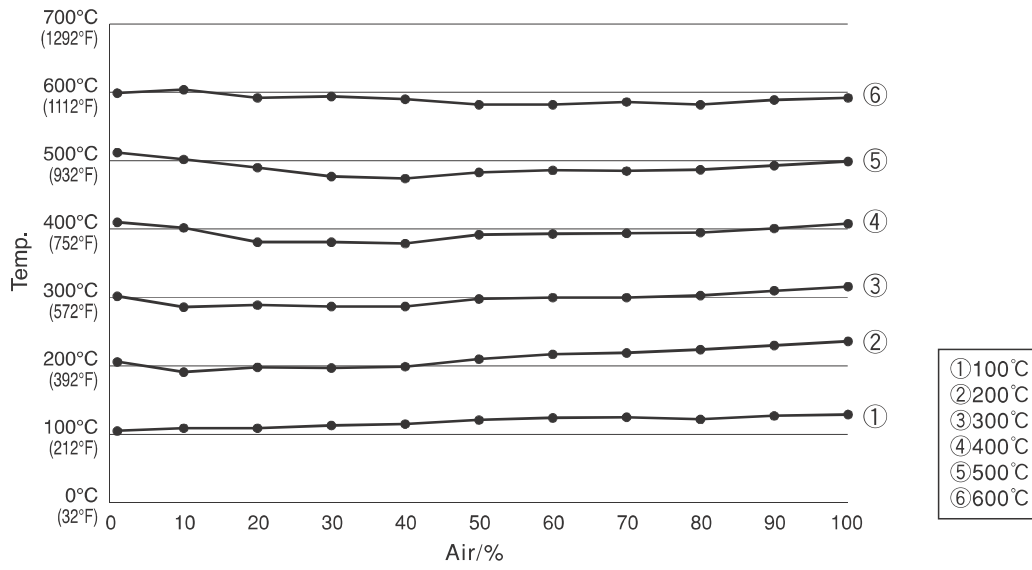

**N51-03 Single  $\phi$ 5.5 (0.22)**

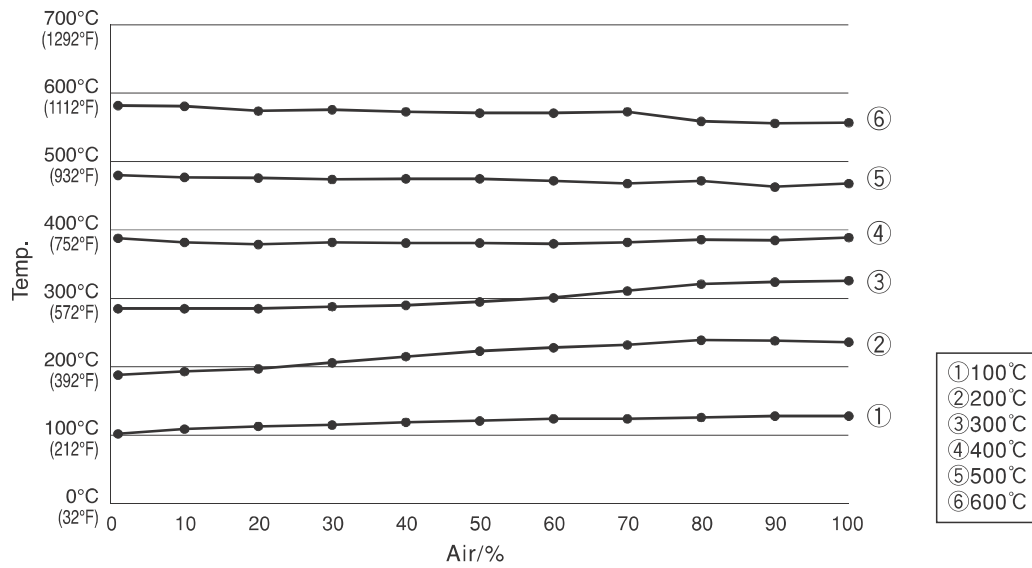

**N51-04 Single  $\phi$ 7.0 (0.28)**

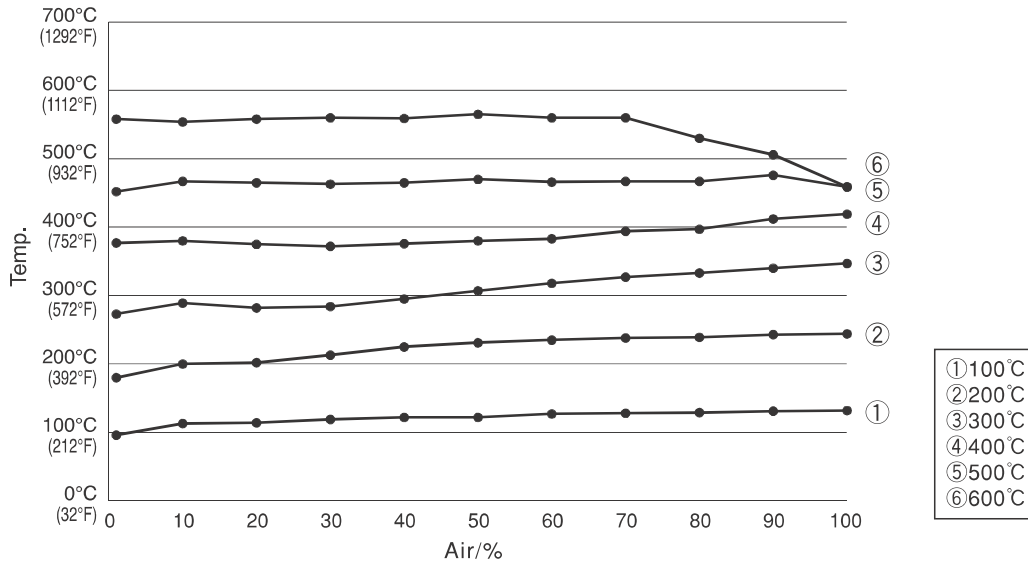

**N51-05 Bent Single 1.5 x 3 (0.06 x 0.12)**

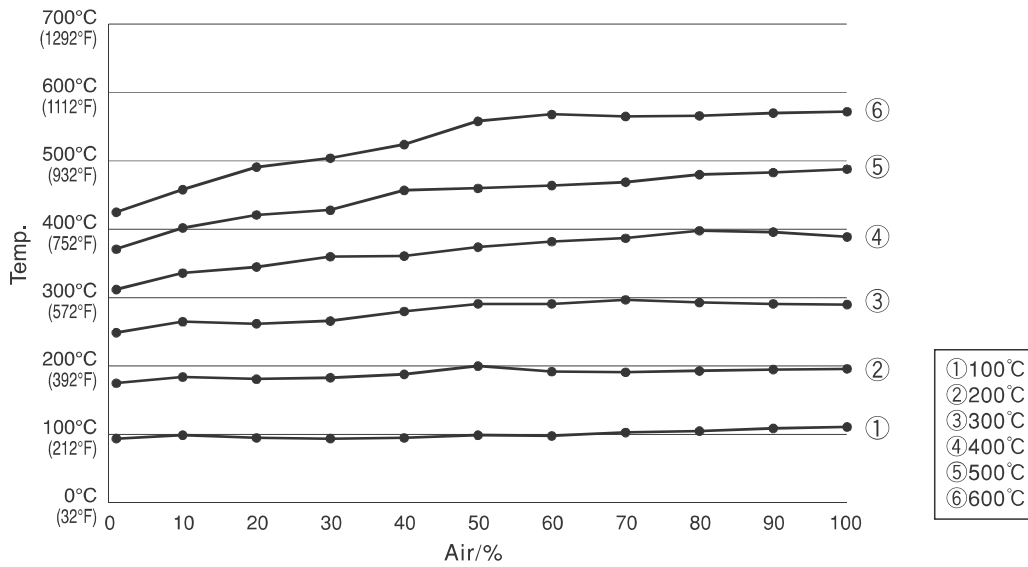

# 10. MAINTENANCE / INSPECTION

## ⚠ CAUTION

Replacing the heating element is very dangerous. Be sure to turn the power switch OFF and be careful of the following procedure when replacing the heating element.

### A. Remove the heating element

#### ⚠ CAUTION

When replacing the heater, please be careful not to apply force, such as vacuum pipe is bent.

1. Remove the 4 screws that attach the heater pipe to the handpiece. Remove the heater pipe.



2. Remove the mica from inside the heater pipe.

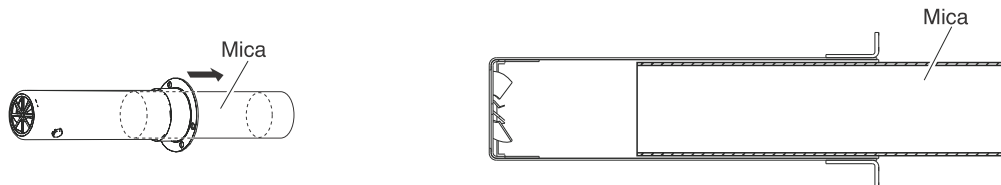

3. Disconnect and remove the heating element assembly.



### B. Measure the resistance value

#### ● Normal heater resistance value

Connect an ohmmeter across the connector terminals (a).

The correct values are approximately:  $14\Omega$  ( $\pm 10\%$  100-110V),  $17\Omega$  ( $\pm 10\%$  120V),  $41\Omega$  ( $\pm 10\%$  220-240V). If the resistance value is incorrect, replace the part.

#### ● Normal sensor resistance value

Connect an ohmmeter across the connector terminals (b). If the resistance value is  $\infty$ , replace the part.

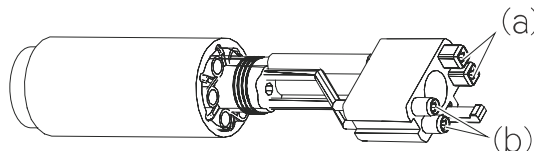

Refer to the instructions included with the replacement part.

#### ⚠ CAUTION

Handle the heating element with care. Never touch the heating element wire!

# 11. ERROR MESSAGE

---

When the error detection software in the HAKKO FR-811 detects an error, a message is displayed to alert the operator. See “Troubleshooting” for procedures to correct the error.

● **Sensor Error (S-E)**

This error occurs when there is the possibility of a sensor failure (or a failure in the sensor circuit). The “S-E” displayed and the power is shut down.

● **Heater Error (H-E)**

This error occurs when the temperature of the hot air is falling even though the heater is on. The “H-E” displayed to indicate the possibility of a heater failure.

● **Fan Error (F-E)**

This error occurs when there is the possibility of a fan failure. The “F-E” displayed and the power is shut down.

● **Bottom heater error (BHE)**

This error occurs when the connection to the bottom heater is incomplete. The “BHE” displayed to indicate the possibility of a heater failure.



# 12. TROUBLE SHOOTING GUIDE

## ⚠ WARNING

Before checking the inside of the HAKKO FR-811 or replacing parts, be sure to disconnect the power plug. Failure to do so may result in electric shock.

- The unit does not operate when the power switch is turned on.

**CHECK** : Is the fuse blown?

**ACTION** : Investigate why the fuse blew and then replace the fuse. If the cause can not be determined, replace the fuse. If the fuse blows again, send the unit in for repair.

- “S-E” is displayed

**CHECK** : Is the sensor broken?

**ACTION** : Measure the resistance value of the sensor. When the resistance value is  $\infty$ , replace the heater.

- “H-E” is displayed

**CHECK** : Is the heater broken?

**ACTION** : Measure the resistance value of the heater. When the resistance value is not within the normal range, replace the heater.

**CHECK** : Is the location of measurement for the thermocouple inappropriate or is the thermocouple mounted improperly?

**ACTION** : Mount the thermocouple to an appropriate location of measurement.

- “F-E” is displayed

**ACTION** : The fan may be broken. Replace the fan with a new one.

- When the S button is pressed, the unit does not operate. (AUTO mode)

**CHECK** : Is the setting not connected to the bottom heater in a state of ON?

**ACTION** : Connect it.

- Profile can not be read from USB memory. Profile error occurs.

**ACTION** : There is a possibility that the data is in damaged or unreadable format. Please prepare the format of the data that can be read.

- “BHE” is displayed

**CHECK** : Is the selector switch off?

**ACTION** : Turn on the selector switch.

**CHECK** : Is the heater burned out?

**ACTION** : Measure the resistance of the heater. If the heater has an open circuit, replace the heater.

**CHECK** : Is the setting for the heater power alert too low (set to too short a time)?

**ACTION** : Change the heater power alert to an appropriate setting.

**CHECK** : Is the location of measurement for the thermocouple inappropriate or is the thermocouple mounted improperly?

**ACTION** : Mount the thermocouple to an appropriate location of measurement.

※ 各言語（日本語、英語、中国語、フランス語、ドイツ語、韓国語）の取扱説明書は以下のURL、HAKKO Document Portalからダウンロードしてご覧いただけます。  
（商品によっては設定の無い言語がありますが、ご了承ください）  
\* 各言語（日本語、英語、中文、法語、ドイツ語、韓国語）的使用説明書可以通過以下網站的HAKKO Document Portal 下載參閱。  
（有一部分的产品沒有設定外語對應，請見諒）  
\* Instruction manual for the language, Japanese, English, Chinese, French, German and Korean can be downloaded from the following URL, HAKKO Document Portal.  
(Please note that some language may not be available depending on the product.)



<https://doc.hakko.com>

# 13. PARTS LIST

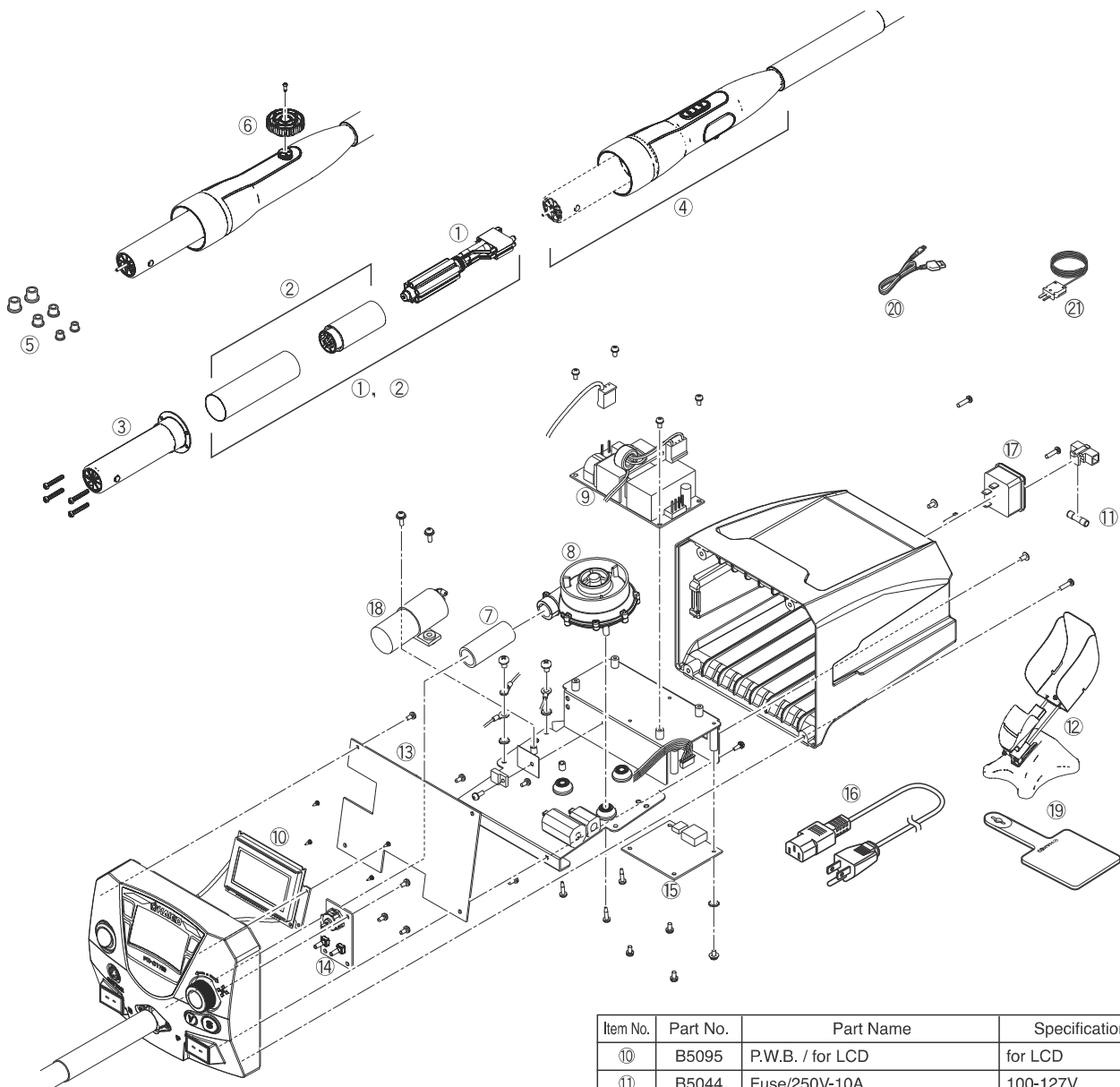

● HAKKO FR-811

Item No.	Part No.	Part Name	Specifications
①, ②	A5005	Heating element assembly	100-110V
	A5006	Heating element assembly	120,127V
	A5007	Heating element assembly	220-240V
①	A5022	Heating element	100-110V
	A5023	Heating element	120,127V
	A5024	Heating element	220-240V
	A5024	Heating element	220-240V
②	B5049	Mica	with heater protection sleeve
③	B5045	Pipe	
④	B5091	Handle with cord assembly	with pipe
⑤	A1520	Pad ø3 mm (0.12 in.)	Set of 5
	A1439	Pad ø5 mm (0.20 in.)	Set of 5
	A1438	Pad ø7.6 mm (0.30 in.)	Set of 5
⑥	B3023	Vacuum pipe adjustment knob (L)	With screw
⑦	B5043	Joint hose	
⑧	B5052	Fan	
⑨	B5053	Power unit	

Item No.	Part No.	Part Name	Specifications
⑩	B5095	P.W.B. / for LCD	for LCD
⑪	B5044	Fuse/250V-10A	100-127V
	B5060	Fuse/250V-6.3A	220-240V
⑫	C5033	Grip stand assembly	
⑬	B5093	P.W.B. / for control	100-127V
	B5094	P.W.B. / for control	220-240V
⑭	B5096	P.W.B. / for encoder switch	
⑮	B5097	P.W.B. / for USB	
⑯	B5054	Power cord, 3 wired cord & American plug	U.S.A.
	B2421	Power cord, 3 wired cord but no plug	
	B2422	Power cord, 3 wired cord & BS plug	India
	B2424	Power cord, 3 wired cord & European plug	220V KTL, 230V CE
	B2425	Power cord, 3 wired cord & BS plug	230V CE, U.K.
	B2426	Power cord, 3 wired cord & Australian plug	
	B2436	Power cord, 3 wired cord & Chinese plug	China
	B3508	Power cord, 3 wired cord & American plug (B)	
B3550	Power cord, 3 wired cord & SI plug		
B3616	Power cord, 3 wired cord & BR plug		
⑰	B2384	Inlet	
⑱	B5092	Pump	
⑲	B2300	Heat resistant pad	
⑳	B5128	Thermocouple	0.2 mm with connector
㉑	B5129	USB cable	1 m

## ■ Connection with the bottom heater.

### ● Bottom heater (sold separately) Packing list

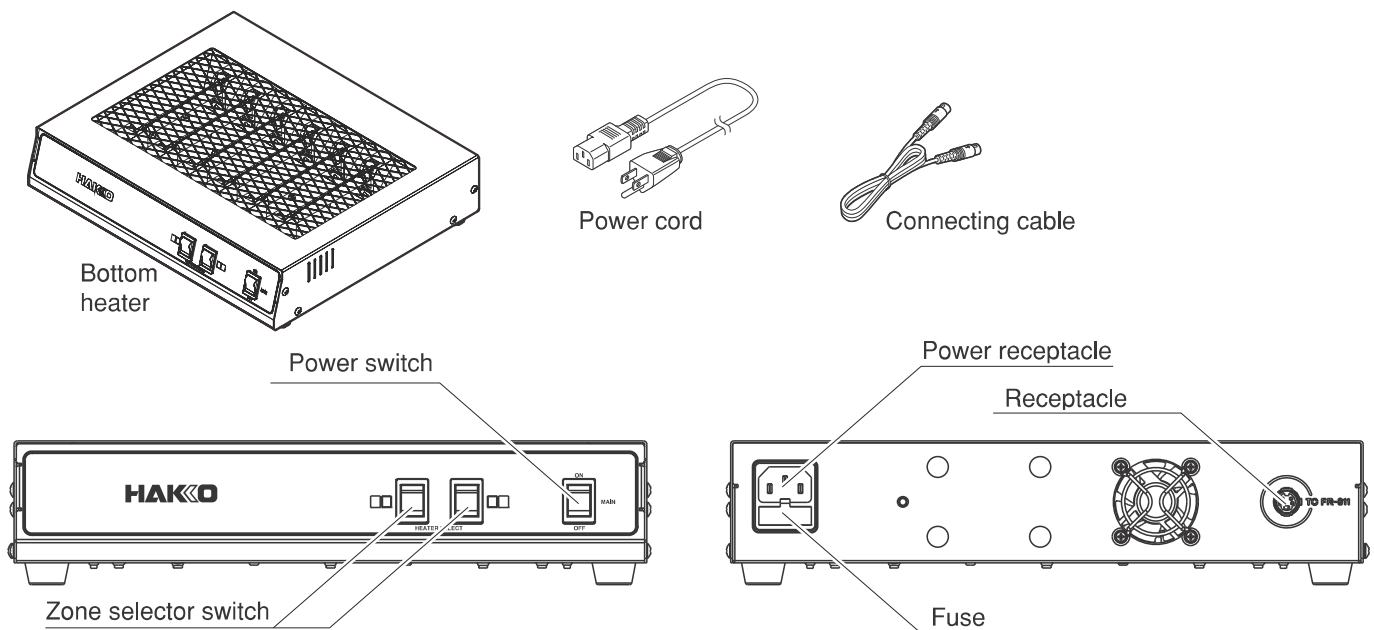

The bottom heater (sold separately) can be connected to the HAKKO FR-811 with the connecting cable. Settings for the bottom heater are set using the HAKKO FR-811.

Refer to the “● MANUAL mode” and “● AUTO mode” for setting instructions.

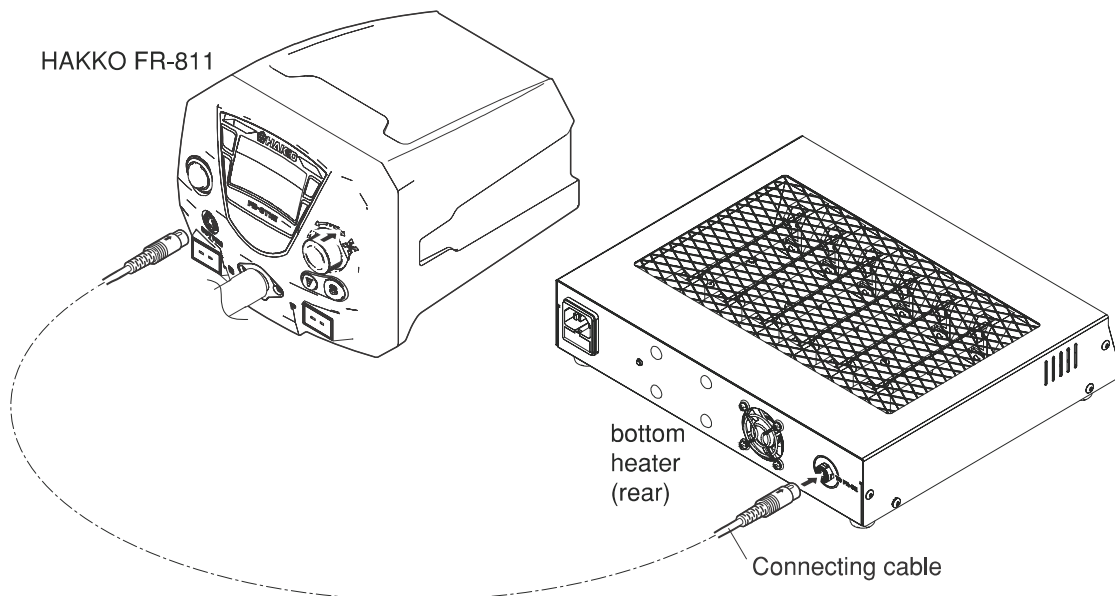

#### ⚠ CAUTION

Please make sure to connect the bottom heater to the same power supply line as the HAKKO FR-811. Failure to do so may cause unstable operations and/or noise to occur.

## ● Combining with other products

The HAKKO FR-811 can be combined with the following products in addition to bottom heaters for operation as a rework system. For usage details, please refer to the instruction manual for each product.

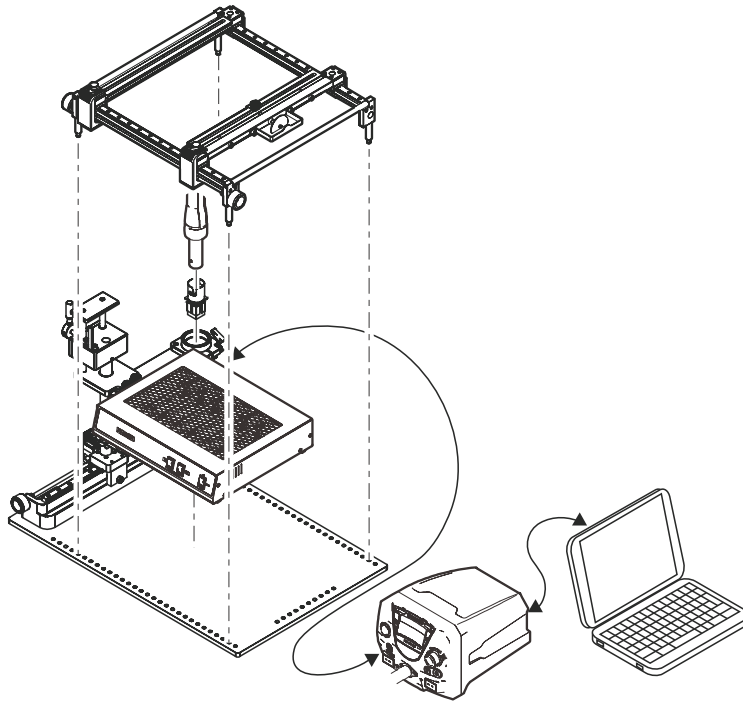

Example: Combination of HAKKO FR-811, Grip Fixture L, bottom heater, and board holder

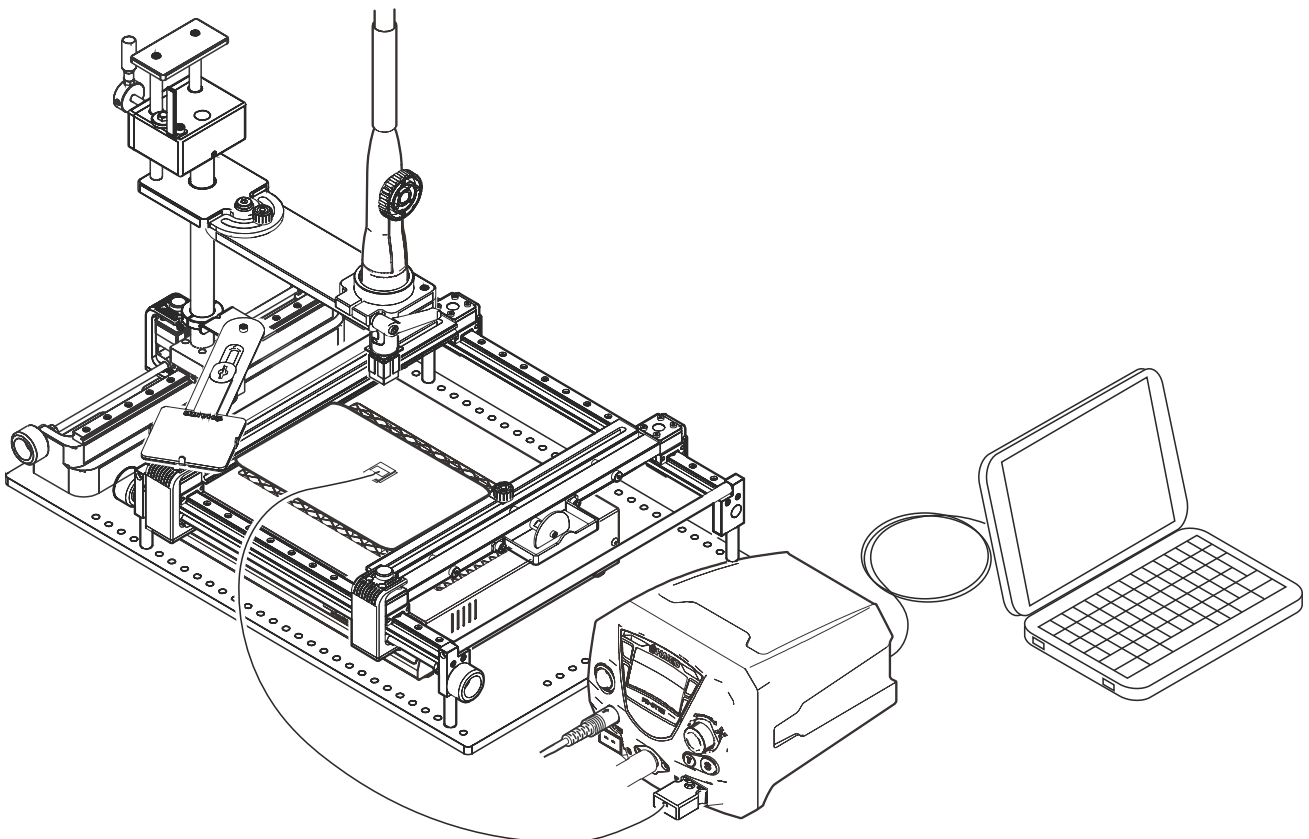

# Optional parts

Product to use in combination with HAKKO FR-811.

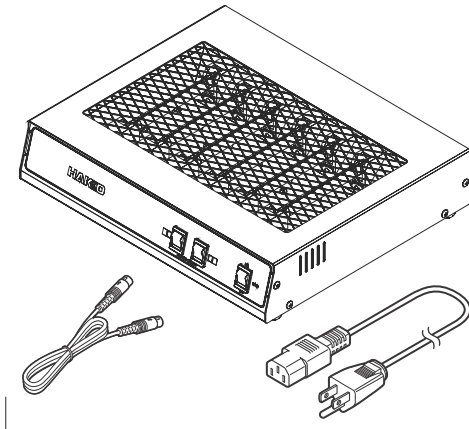

①

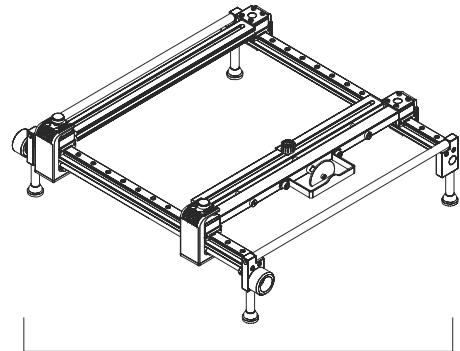

②

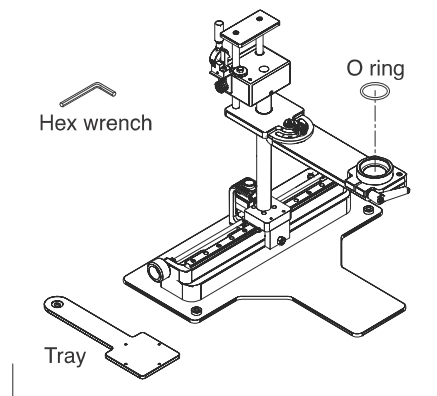

③

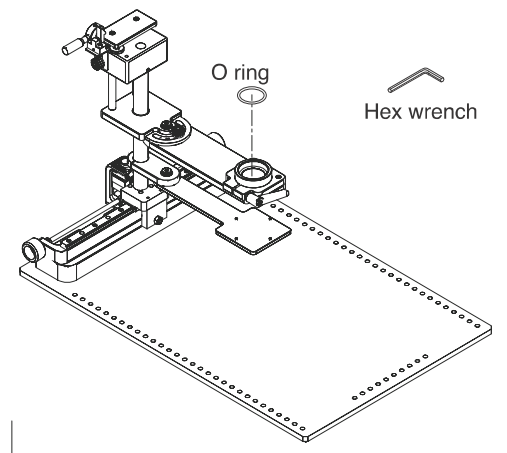

④

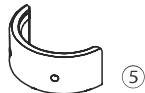

⑤



⑥

## ● Optional parts

Item No.	Part No.	Part Name	Specifications
①	C5014	Bottom heater	110V American plug
	C5015	Bottom heater	127V BR plug
	C5016	Bottom heater	120V American plug
	C5017	Bottom heater	220V American plug
	C5018	Bottom heater	220V Chinese plug
	C5019	Bottom heater	220V European plug
	C5020	Bottom heater	220V BR plug
	C5021	Bottom heater	230V BS plug
	C5022	Bottom heater	230V SI plug
	C5023	Bottom heater	230V European plug CE
	C5024	Bottom heater	230V BS plug CE
	C5025	Bottom heater	220 - 240V 3 wired cord but no plug
	C5026	Bottom heater	230 - 240V Australian plug
	C5037	Bottom heater	220V European plug KTL
②	C5027	Board holder	
③	C5028	Grip Fixture M	
④	C5029	Grip Fixture L	
⑤	B5059	Adapter/ for fixture (C1392B)	×2
⑥	B5127	Thermocouple	with 0.1mm connector
	B5130	Heat-resistant tape	set of 100

# OPTIONAL PARTS (Nozzle)

## ● Straight nozzle

N51-01 Single  $\phi 2.5$

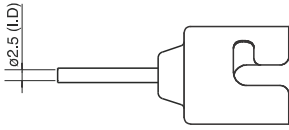

N51-02 Single  $\phi 4$

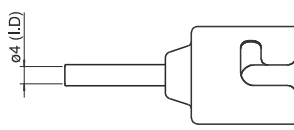

N51-03 Single  $\phi 5.5$

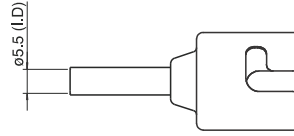

N51-04 Single  $\phi 7$

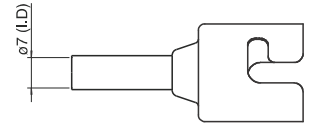

N51-05 Bent single 1.5x3

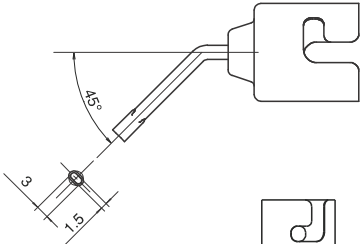

N51-50

with N51-01, N51-03, N51-04, N51-05

## ● BGA nozzle

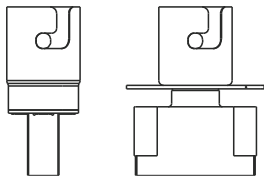

N51-10 BGA 4 x 4

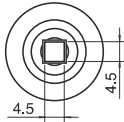

N51-11 BGA 6 x 6

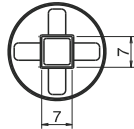

N51-12 BGA 8 x 8

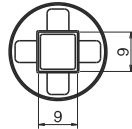

N51-13 BGA 10 x 10

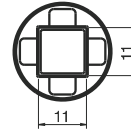

N51-14 BGA 12 x 12

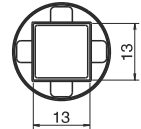

N51-15 BGA 14 x 14

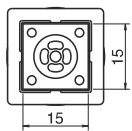

N51-16 BGA 15 x 15

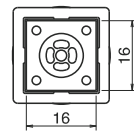

N51-17 BGA 17 x 17

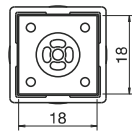

N51-18 BGA 18 x 18

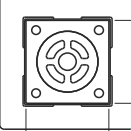

N51-19 BGA 20 x 20

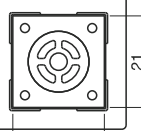

N51-20 BGA 22 x 22

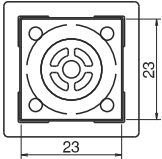

N51-21 BGA 24 x 24

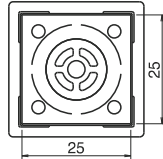

N51-22 BGA 27 x 27

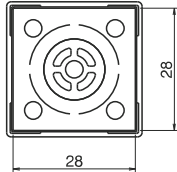

N51-23 BGA 29 x 29

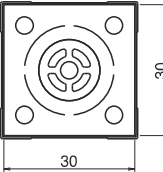

N51-24 BGA 35 x 35

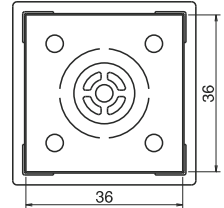

N51-25 BGA 38 x 38

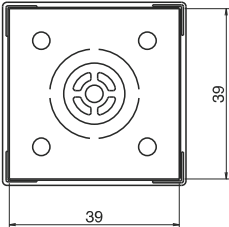

N51-26 BGA 40 x 40

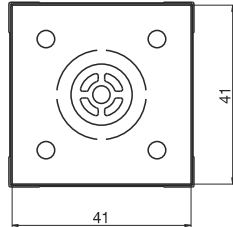

# 14. WIRING DIAGRAM

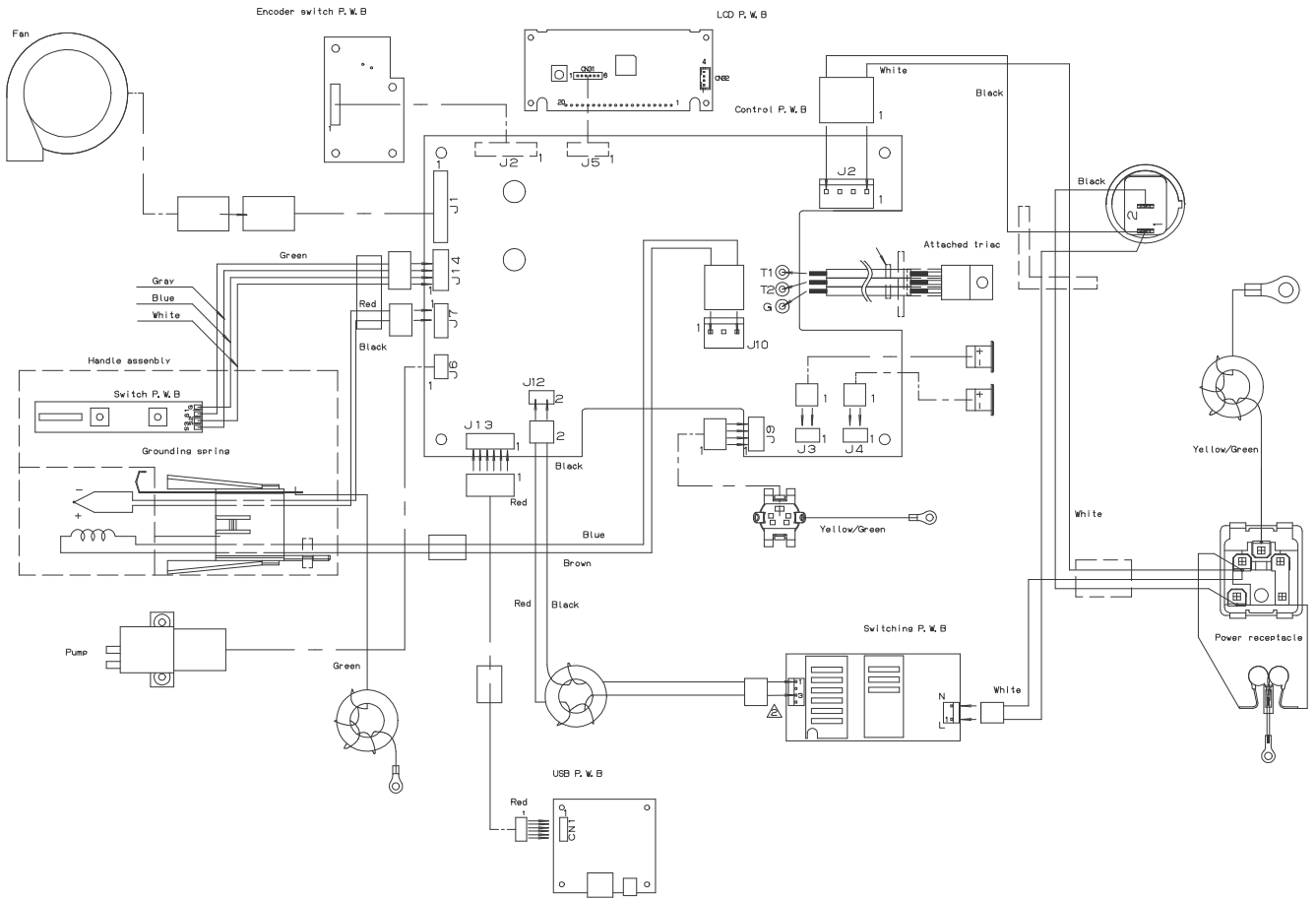

# TBK

**TBK**

**Technisches Büro Kullik GmbH**

Industriestraße 27

56276 Großmaischeid

Tel.: + 49. (0) 26 89.92 770-0

Fax: + 49. (0) 23 89.92 770-10

[tbk@kullik.com](mailto:tbk@kullik.com)

[www.tbk-kullik.com](http://www.tbk-kullik.com)



**HAKKO CORPORATION**

**HEAD OFFICE**

4-5, Shiokusa 2-chome, Naniwa-ku, Osaka 556-0024 JAPAN

TEL: +81-6-6561-3225 FAX: +81-6-6561-8466

<http://www.hakko.com> E-mail: [sales@hakko.com](mailto:sales@hakko.com)

**OVERSEAS AFFILIATES**

**U.S.A.: AMERICAN HAKKO PRODUCTS, INC.**

TEL: (661) 294-0090 FAX: (661) 294-0096

Toll Free (800)88-HAKKO

<http://www.hakkousa.com>

**HONG KONG: HAKKO DEVELOPMENT CO., LTD.**

TEL: 2811-5588 FAX: 2590-0217

<http://www.hakko.com.hk>

E-mail: [info@hakko.com.hk](mailto:info@hakko.com.hk)

**SINGAPORE: HAKKO PRODUCTS PTE LTD.**

TEL: 6748-2277 FAX: 6744-0033

<http://www.hakko.com.sg>

E-mail: [sales@hakko.com.sg](mailto:sales@hakko.com.sg)

Please access to the following address for the other Sales affiliates.

<http://www.hakko.com>