

## THERMAL WIRE STRIPPER Instruction Manual

Thank you for purchasing the HAKKO FT-801 Thermal Wire Stripper.  
Please read this manual before operating the HAKKO FT-801.  
Keep this manual readily accessible for reference.

### 1. PACKING LIST AND PART NAMES

Please make sure that all items listed below are included in the package.

HAKKO FT-801 Station	1	Handpiece holder	1
HAKKO FT-8002	1	Connecting cable	1
Lead adjuster	1	Blade removal tool	1
Power cord	1	Wire material label	1
		Instruction manual	1

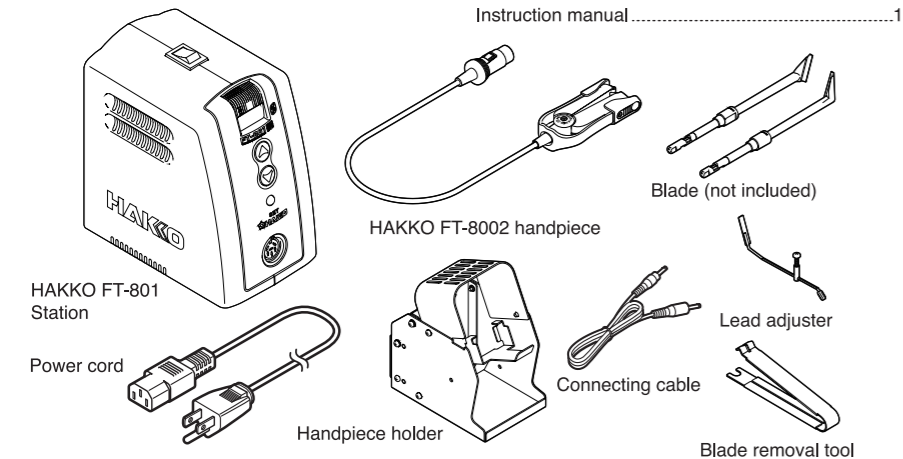

### 2. SPECIFICATIONS

#### ● HAKKO FT-801

Power Consumption	68W
-------------------	-----

#### ● Station

Output	24V
Dimensions	80(W) x 130(H) x 131(D) mm
Weight	1.2 kg

#### ● HAKKO FT-8002 (Handpiece)

Power Consumption	64W (24V)
Length of Cord	1.3m
Length (w/o cord, blade)	96mm
Weight (w/o cord, blade)	48g

**NOTE:**  
\*Specifications and design are subject to change without notice.  
\*This product is protected against electrostatic discharge.

#### ■ Electrostatic Protection

This product includes such features as electrically conductive plastic parts and grounding of the handpiece and station as measures to protect the device to be soldered from the effects of static electricity. Be sure to observe the following instructions:

1. The handle and other plastic parts are not insulators, they are conductors. When making repairs or replacing parts, take sufficient care not to expose live electrical parts or damage insulation materials.
2. Be sure to ground the unit during use.

\* 各言語 (日本語、英語、中国語、フランス語、ドイツ語、韓国語) の取扱説明書は以下のURL、HAKKO Document Portalからダウンロードしてご覧いただけます。  
(商品によっては設定の無い言語がありますが、ご了承ください)  
\* 各言語 (日本語、英語、中文、法語、ドイツ語、韓国語) の取扱説明書は以下のURLのHAKKO Document Portal 下欄参照。  
(有一部分の產品沒有設定外語對應，請見諒)  
\* Instruction manual in the language of Japanese, English, Chinese, French, German and Korean can be downloaded from the HAKKO Document Portal.  
(Please note that some languages may not be available depending on the product.)

<https://doc.hakko.com>

**HAKKO CORPORATION**  
HEAD OFFICE  
TEL: +81-6-6561-3225 FAX: +81-6-6561-8466  
<http://www.hakko.com> E-mail: sales@hakko.com

OVERSEAS AFFILIATES  
U.S.A.: AMERICAN HAKKO PRODUCTS, INC.  
TEL: (661) 294-0090 FAX: (661) 294-0096  
Toll Free (800)88-HAKKO  
<http://www.hakkousa.com>

HONG KONG: HAKKO DEVELOPMENT CO., LTD.  
TEL: 2811-5588 FAX: 2590-0217  
<http://www.hakko.com.hk>

SINGAPORE: HAKKO PRODUCTS PTE., LTD.  
TEL: 6748-2277 FAX: 6744-0033  
<http://www.hakko.com.sg>  
E-mail: sales@hakko.com.sg

Please access to the following address for the other Sales affiliates.  
<http://www.hakko.com>  
Copyright © 2010 HAKKO Corporation. All Rights Reserved.

#### 中國RoHS: 產品中有毒有害物質或元素的名稱及含量

部件名稱	有毒有害物質或元素					
	鉛(Pb)	汞(Hg)	鎘(Cd)	六價鉻 (Cr(VI))	多溴聯苯 (PBB)	多溴二苯醚 (PBDE)
導線調節器	×	○	○	○	○	○
電路板	×	○	○	○	○	○
手柄	×	○	○	○	○	○
插頭	×	○	○	○	○	○
插座	×	○	○	○	○	○

○ : 表示該有毒有害物質在該部件所有均質材料中的含量均在SJ/T 11363-2006標準規定的限量要求以下。  
× : 表示該有毒有害物質至少在該部件的某一均質材料中的含量超出SJ/T 11363-2006標準規定的限量要求。

### 3. WARNINGS, CAUTIONS, NOTES AND EXAMPLES

#### ⚠ WARNING

Warnings, cautions and notes are placed at critical points in this manual to direct the operator's attention to significant items. They are defined as follows:

⚠ **WARNING:** Failure to comply with a WARNING may result in serious injury or death.

⚠ **CAUTION:** Failure to comply with a CAUTION may result in injury to the operator, or damage to the items involved.

**NOTE:** A NOTE indicates a procedure or point that is important to the process being described.

#### ⚠ CAUTION

After the power is turned on, the blade temperature can reach as high as 800°C (1472°F). Improper handling may cause burns or fire. Be sure to observe the following precautions. This unit is approved for use as a thermal wire stripper. Misuse of this product may result in damage to the unit or injury.

- Do not touch the blade or metal parts near the blade.
- Do not allow the blade to come close to, or touch, flammable materials.
- Inform others in the area that the unit is hot and should not be touched.
- Turn the power off when not in use, or left unattended.
- Turn the power off when changing parts or storing the HAKKO FT-801.
- This appliance is not intended for use by persons (including children) with reduced physical, sensory or mental capabilities, or lack of experience and knowledge, unless they have been given supervision or instruction concerning use of the appliance by a person responsible for their safety.
- Children should be supervised to ensure that they do not play with the appliance.

#### ● Observe the following precautions to prevent accidents or damage to the unit.

- Do not use the HAKKO FT-801 for applications other than wire stripping.
- Do not strike the blade against workbench to remove stripped insulation debris. This will damage the blade.
- Do not modify the HAKKO FT-801.
- Do not allow the HAKKO FT-801 to become wet, or use it when hands are wet.
- Since smoke is produced when using the wire stripper, be sure the work area is well ventilated.
- While using HAKKO FT-801, do not do anything which may cause bodily harm or physical damage.

### 4. Assembly

#### ● Installing the blades

1. When attaching the blades, press them firmly until the flange is locked into the handpiece. When the blades click, they are fully inserted. (As shown in right figure)

#### NOTE:

- Unless both blades are inserted fully, the blades will not heat.
- After installing an optional blade set close the handle two or three times to check the alignment of both blades as shown in the illustration.

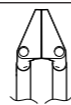

#### ● How to attach the lead adjuster

1. Remove a screw holding lead adjuster.
2. From the top side of the handpiece, insert the screw for the lead adjuster into the hole. From the opposite side of the handpiece (with the groove), insert the support post of the lead adjuster into the hole. Adjust the length of the lead adjuster before tightening the screw firmly.

#### NOTE:

When attaching the lead adjuster, be sure the lead adjuster is facing in the proper direction. (Refer to right figure)  
Attach the lead adjuster so that the end face of the lead adjuster is parallel to that of the blade.

#### ● Removing the blades.

1. Turn off the power and allow the blades to cool.
2. Hook the blade flange with the blade removal tool and pry the blade upward to release it from the handpiece. (Fig.1)
3. Grab the blade using the blade removal tool and remove it from the handpiece. (Fig.2)

#### ⚠ CAUTION

- Before changing blades, be sure to turn the power off and allow the blade to cool to room temperature.
- When removing the blades, be sure the blades are sufficiently cooled.
- Be sure to use the blade removal tool even when the blade is not hot.
- Be sure you do not touch the end of the blade removal tool as it may be hot from touching the blade during removal.

**NOTE:**  
Be sure the blades are facing in the proper direction. When the blades click, they are fully inserted.

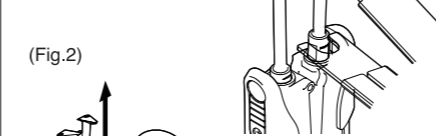
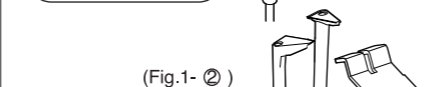
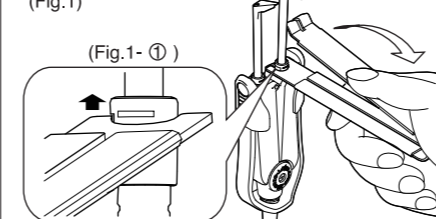
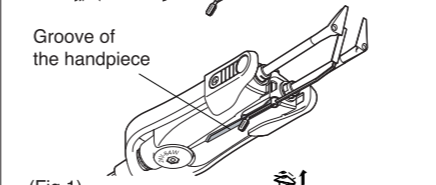
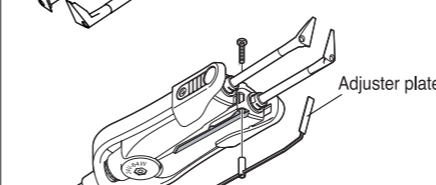
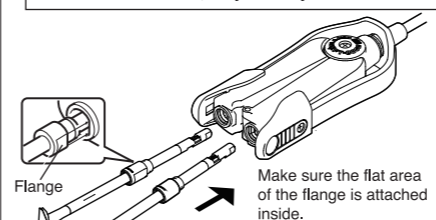

### 4. Assembly

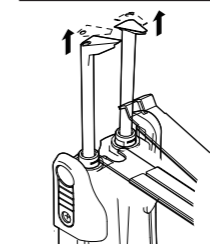

**NOTE:**  
When removing two blades at the same time, hook the flange of both blades with the blade removal tool.

#### ● Connection

1. Connect the power cord to the power receptacle on the rear of the station.
2. Place the HAKKO FT-8002 in the handpiece holder.
3. Plug the power cord into a ground wall socket.

#### ● Use of the sleep function

When using the sleep function, insert one end of the connecting cable into the jack at the back of the handpiece holder and the other end into the jack at the back of the station to connect them.

#### ⚠ CAUTION

Be sure to turn off the power before connecting or disconnecting the connecting cable. Securely insert the connecting cable all the way in to the jack.

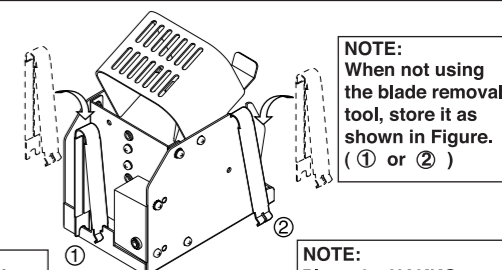

**NOTE:**  
When not using the blade removal tool, store it as shown in Figure. (1 or 2)

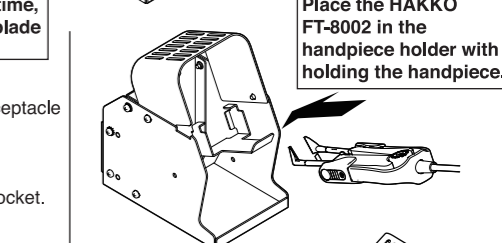

**NOTE:**  
Place the HAKKO FT-8002 in the handpiece holder with holding the handpiece.

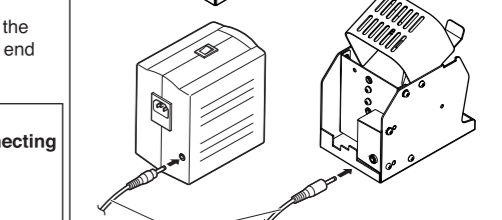

### 5. OPERATION

#### ● Controls and displays

##### Controls

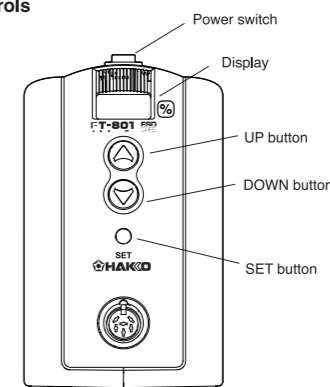

▲ Pressing and holding, the power setting will be changed. Increase the displayed value when a setting is changed.

▼ Pressing and holding, the power setting will be changed. Decrease the displayed value when a setting is changed.

○ Pressing and holding, the power setting will be changed. Displays settings already stored.

1. Turn the power switch on.
2. **888** lights for two seconds.
3. The power setting will flash as the blade temperature increases. Once the blade temperature stabilizes, the power setting will stop flashing and the unit is ready to use.

#### Recommended Power Settings

Insulation Material	Symbol	Setting
Polyvinyl Chloride	PVC	10
Polyethylene	PE	10
Nylon	PA	20
Kynar®	PVDF	30
Tefzel®	ETFE	40
Silicone	SI	45
Teflon®	PTFE	55

#### ● Setting / Changing the power setting

Ex) Changing the power setting from 50% to 65%.

1. Press and hold the ▲, ▼ or SET button for at least two seconds. The display will begin to flash and the station enters the output change mode.
2. Press ▲ or ▼ button to set the desired value. When the desired value is displayed, press the set button. when the blade temperature stabilizes at the new power setting, the display will stop flashing and the unit is ready to use.

#### NOTE:

- The power setting range is 5% to 100%.
- The power setting can be changed in increments of 5%.

**⚠ CAUTION**  
● By default, the power is set to 50%.  
● Blades are hot. Place the handpiece on the handpiece holder when not in use.

#### For Reference Only NOTE:

The reference setting shown on the left may vary depending on the thickness and composition of the wire. Oxidation and/or improper blade maintenance may result in requiring higher settings

Kynar® is a registered trademark of Arkema Inc. Tefzel® and Teflon® are registered trademarks of E. I. du Pont de Nemours and Company or its affiliates.

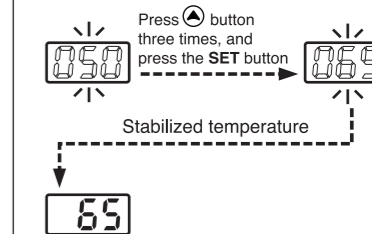

## 5. OPERATION

### ●How to use lead adjuster

Lead adjuster is a stop for setting the fixed length of the wire to be stripped. Set the length of the wire to be stripped by adjusting the distance between the stop and the blade. Secure the lead adjuster by tightening the screw. (Stripping length : 1 ~ 25 mm)

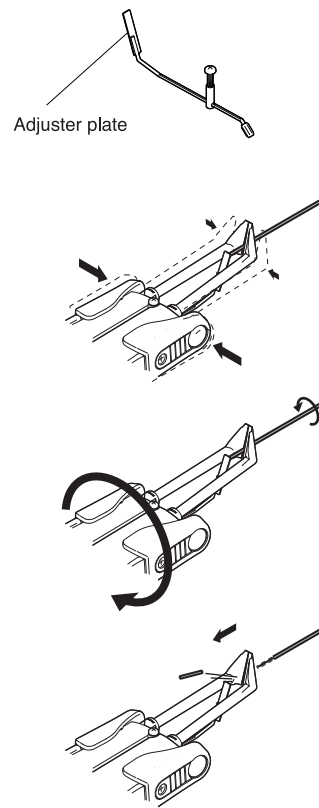

### ●Removing wire insulation

1. Align the wire end to the lead adjuster.
2. Pinch the wire in the proper hole between the blades in accordance with the wire diameter. The pinched section will be melted by the heated blades.
3. Turn the wire and blade to spread the heat uniformly over the insulation.
4. Pull the wire and handpiece away from each other to remove the insulation on the end of the wire.

## 6. PARAMETER SETTINGS

### ●Parameter entry mode process

Select the parameter entry mode using the following operation.

- 1 Turn the power on while pressing the  $\Delta$  and  $\nabla$  button. The station enters the parameter entry mode.
  - 2 Select the parameter number. Parameter number  $14$  is initially flashed. Use the  $\Delta$  or  $\nabla$  button to change the parameter number. When pressing  $\Delta$  button,  $19 \rightarrow 02 \rightarrow 18$  is displayed in order. When pressing  $\nabla$  button,  $18 \rightarrow 02 \rightarrow 19$  is displayed. Select the parameter number and press the SET button to go to the settings.
  - 3 Select the parameter settings. The current setting is initially displayed. Use the  $\Delta$  or  $\nabla$  button to enter the parameter setting. Press the SET button to return to setting the parameter number.
- After the necessary parameter are set, press and hold the SET button in steps 2 or 3 above for two seconds.
- 4 The display changes to  $04$ , and the station asks whether to exit the parameter entry mode. Select the  $04$  and press the Set button to exit the parameter entry mode.

**NOTE:**  
Each time the  $\Delta$  or  $\nabla$  button is pressed, the display toggles between the following displays :  $04$  and  $0n$ .  
When  $0n$  is selected, the parameter number selection screen in step 2 is displayed.

### ●The HAKKO FT-801 has the following parameters.

Parameter No.	LED display	Setting	Default setting
Password setting	$00$ or $01$ or $02$	$00$ : OFF $01$ : Partial On $02$ : ON	$00$ : OFF
	A,b,C,d,E,F (3 digit)	$01$ or $02$	---
Power upper limit setting	$19$	Set by 5%	$80$
Auto sleep on/off setting	$02$	$00$ ~ $30$	$15$ (min)
Auto shutoff on/off setting	$18$	$00$ ~ $30$	$15$ (min)

### $14$ : Password setting

In password setting mode, power setting value and parameter setting can be locked. Password has six kinds of letters : A, b , C , d , E , F  
Select the 3 digits to set the password. There are three settings in password setting.

- $00$  : Password is OFF( not locked)
- $01$  : Password is locked in parameter setting mode.  
Power upper limit setting is ON. (PARTIAL lock)
- $02$  : In power setting and parameter setting mode, password is locked. (FULL lock)

## 6. PARAMETER SETTINGS

### $14$ : Password setting

#### \*How to set the password

Example : Setting the password lock for a FULL lock, and setting the password to  $00b0$ .

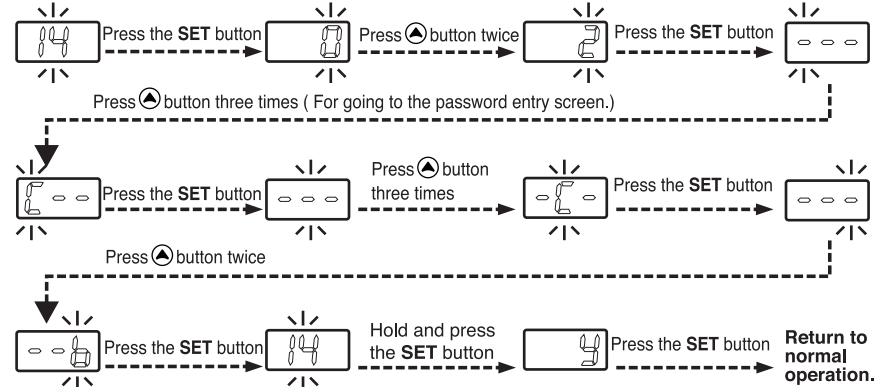

#### \*How to enter the password (Password is ON and enter $00b0$ )

**NOTE:**  
When password setting is ON, password is required to enter the power setting and parameter setting mode.

**Parameter setting**  
Turn the power on while pressing the  $\Delta$  and  $\nabla$  button.

**Or**

**Power setting**  
Press and hold the  $\Delta$ ,  $\nabla$  or SET button for at least two seconds.

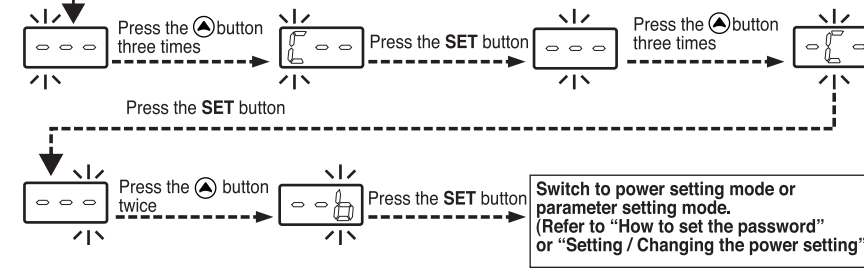

### $19$ : Power upper limit setting

When password setting mode is  $01$  (partial on) or  $02$  (ON), power upper limit setting is activated. Output value exceeding the set value in parameter setting is not effective. Output value can not be set 80% or more at factory default.

### $02$ : Auto sleep setting

Auto sleep setting is to keep output about 50% or decrease the temperature of the blades and power consumption. Set the time until the auto sleep function activates after handpiece is set on the handpiece holder.

Display :  $SLP$  lights

$00$  : The auto sleep function is off.

$01$  ~  $30$  : The auto sleep time can be set in units of minutes. (up to 30 minutes).

**NOTE:**

Connect the connecting cable both station and handpiece holder before the auto sleep function activates. When the auto sleep function is on, removing the handpiece from the handpiece holder and pressing the  $\Delta$  or  $\nabla$  button resumes operations.

### $18$ : Auto shutoff setting

When the handpiece is set on the handpiece holder and no operation is performed for a predetermined time, the auto shutoff function activates. Power to the heater is shut off automatically.

Display :  $---$  lights

$00$  : The auto shutoff function is off.

$01$  ~  $30$  : The auto shutoff function is on. (Number to be set is the time until the auto shutoff function activates after the sleep function worked.)  
The auto shutoff time can be set in units of minutes.(up to 30 minutes.)

Ex.) Set for 10 minutes in the auto sleep setting.  
/ Set for 20 minutes in the auto shutoff setting.

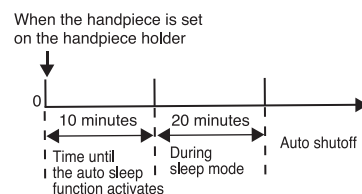

#### CAUTION

Do not leave the HAKKO FT-801 for a long time with auto shutoff function activated. Turn the power off when you do not use the HAKKO FT-801 for a long time.

**NOTE:**

Connect the connecting cable both station and handpiece holder before the auto shutoff function activates. When the auto shutoff function is on, removing the handpiece from the handpiece holder and pressing the  $\Delta$  or  $\nabla$  button resumes operations.

## 7. MAINTENANCE

Performing proper and periodic maintenance ensures proper operation of the tool and extends the product life. Apply the following service procedure as dictated by the conditions of the usage.

### ● Blade

#### 1. Maintenance

If the blades become oxidized, it will be difficult to melt the insulation. Remove oxide and stripped insulation debris from the blades with a wire brush. Use light pressure when cleaning the blades. Excessive pressure can damage the blades and shorten blade life.  
Do not clean the blades when they are hot.

#### 2. After use

When not using the unit, be sure to place it in the handpiece holder and set the power save mode. Operating the blades at high temperature without stripping insulation for extended time may shorten the heating element life. If you will not use the unit for a long time, turn off the power switch.

## 8. CHECKING PROCEDURE

#### WARNING

Unless otherwise specified, turn off the power switch and pull the power plug out before performing the following procedures

#### 1. Check for a broken heater

Measure the resistance across these positions.

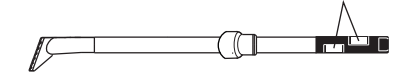

Check the heating element for electric fault. Measure the heater element at room temperature (15 to 25°C; 59 to 77°F).  
Normal resistance value on is  $4.6\Omega \pm 10\%$ . If resistance value is abnormal, replace the blade with a new one.

#### 2. Checking the connection cord for breakage.

1. Attach normal blades (with normal heater resistance) to both handles.
2. Measure the resistance between the connector pins. Between pin 1 and pin 5:  $8.2$  to  $10\Omega$ .  
If the resistance value is different from the above values, replace the HAKKO FT-8002.

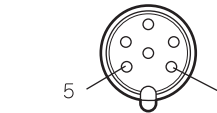

#### 3. Replacing the fuse

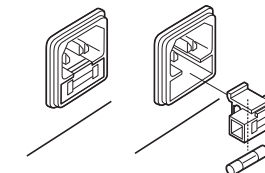

1. Unplug the power cord from the power receptacle.
2. Remove the fuse holder.
3. Replace the fuse.
4. Put the fuse holder back in place.

## 9. TROUBLE SHOOTING GUIDE

#### WARNING

- Before repairing the unit, be sure to disconnect the power plug. Failure to do so may cause electric shock.
- If the power cord is damaged, it must be replaced by the manufacturer, its service agent or similarly qualified person in order to avoid personal injury or damage to the unit.

●The unit does not operate even when the power switch is turned on.

**CHECK** : Is the power cord or the connection plug disconnected?

**ACTION** : Connect the power cord and the connection plug.

**CHECK** : Is the fuse blown?

**ACTION** : Investigate why the fuse blew and then replace the fuse. Even if the cause can not be determined, replace the fuse. If the fuse blows again, send the entire unit for repair.

●The display  $H-E$  flashes

**CHECK** : Are the blades inserted firmly?

**ACTION** : Insert the blades fully.

**CHECK** : Is the connection cord disconnected? Is the heating element broken?

**ACTION** : Refer to how to check the connection cord and/or the heating element for breakage.

●  $---$  is displayed.

**ACTION** : Turn on the power switch again.

If the same phenomenon occurs again, return the unit for repair.