

SOLDERING STATION

FN-1010

Instruction Manual



Thank you for purchasing HAKKO FN-1010 soldering station.

This product is a soldering iron with added functions for use with peripheral equipment such as thermometer.

Please read the manual carefully

before operating the HAKKO FN-1010.

Please keep this manual readily accessible for reference.



Table of Contents

1. PACKING LIST	1
2. SPECIFICATIONS.....	1
3. WARNINGS, CAUTIONS AND NOTES.....	2
4. PARTS NAMES.....	3
4-1 Unit	3
4-2 Normal display screen.....	3
5. INITIAL SETUP	4
5-1 Iron holder	4
5-2 Handpiece	4
5-2-1 Inserting tip	4
5-2-2 Removing tip	5
5-2-3 About tips	5
5-3 Station	5
6. OPERATION	6
6-1 Setting/changing the temperature.....	6
6-2 Selecting a preset temperature.....	7
6-3 Setting/changing the offset.....	7
6-3-1 Direct input.....	7
6-3-2 IR input.....	8
6-4 Performing “Auto Cal”	9
6-5 Checking “Auto Cal” information.....	10
6-6 Setting the load detection function	10
6-7 Load repetition count alarm.....	10
7. MAINTENANCE	12
8. TROUBLE SHOOTING GUIDE.....	13

1. PACKING LIST

Please check to make sure that all items listed below are included in the package.

HAKKO FN-1010 soldering station.....	1	Tip cleaner (FT401-81).....	1
Soldering iron (FN1101-81).....	1	Cleaning wire (A1561).....	1
Power cord.....	1	Instruction manual.....	1
Iron holder.....	1		

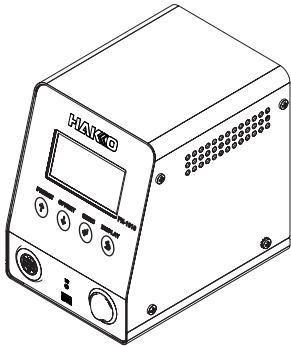

HAKKO FN-1010 soldering station

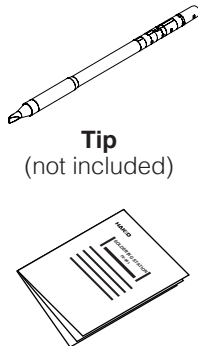

Tip
(not included)

Instruction manual

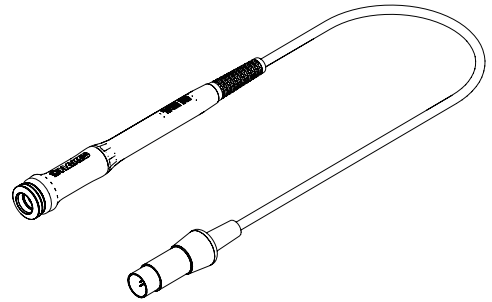

Soldering iron
(FN1101-81)

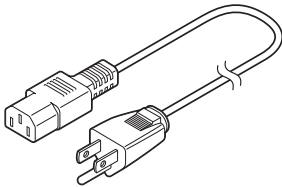

Power cord



Tip cleaner
(FT401-81)



Cleaning wire
(A1561)

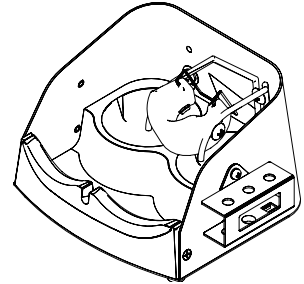

Iron holder
(FH210-81)

2. SPECIFICATIONS

Power consumption	100W
Temperature range^{*1}	50 – 450°C (120 – 840°F)
Temperature stability	±3°C (±5°F) at idle temperature

Station

Output	21V
Dimensions	104 (W) x 138 (H) x 152 (D) mm
Weight	1.9 kg

HAKKO FN-1101 (soldering iron)

Power consumption	95W (21V)
Tip to ground resistance	<2Ω
Tip to ground potential	<2mV
Length of cord	1.2 m
Length (w/o cord)	180 mm (with 2.4D tip)
Weight (w/o cord)	32 g (with 2.4D tip)

*1 The temperature was measured using the HAKKO FG-101 thermometer.

- This product is protected against electrostatic discharge.
- Specifications and design are subject to change without notice.

CAUTION

This product includes such features as electrically conductive plastic parts and grounding of the handpiece and station as measures to protect the device to be soldered from the effects of static electricity. Be sure to observe the following instructions:

1. The handle and other plastic parts are not insulators, they are conductors. When replacing parts or repairing, take sufficient care not to expose live electrical parts or damage insulation materials.
2. Be sure to ground the unit during use.

3. WARNINGS, CAUTIONS AND NOTES

Warnings, cautions and notes are placed at critical points in this manual to direct the operator's attention to significant items. They are defined as follows:

⚠ WARNING: Failure to comply with a WARNING may result in serious injury or death.

⚠ CAUTION: Failure to comply with a CAUTION may result in injury to the operator, or damage to the items involved.

NOTE: A NOTE indicates a procedure or point that is important to the process being described.

⚠ WARNING

When power is ON, the tip will be hot.

To avoid injury or damage to personnel and items in the work area, observe the following:

- Do not touch the tip or the metal parts near the tip.
- Do not allow the tip to come close to, or touch, flammable materials.
- Inform others in the area that the unit is hot and should not be touched.
- Turn the power off when not in use, or left unattended.
- Turn the power off when changing parts or storing the HAKKO FN-1010.
- The unit is for a counter or workbench use only.
- This appliance can be used by children aged from 8 years and above and persons with reduced physical, sensory or mental capabilities or lack of experience and knowledge if they have been given supervision or instruction concerning use of the appliance in safe way and understand the hazards involved.
- Children shall not play with the appliance.
- Cleaning and user maintenance shall not be made by children without supervision.

To prevent accidents or damage to the HAKKO FN-1010, be sure to observe the following:

⚠ CAUTION

- Do not use the HAKKO FN-1010 for applications other than soldering.
- Do not strike the iron against hard objects to remove excess solder.
This will damage the iron.
- Do not modify the HAKKO FN-1010.
- Use only genuine HAKKO replacement parts.
- Do not allow the HAKKO FN-1010 to become wet, or use it when hands are wet.
- Be sure to hold the plug when inserting or removing the iron cord.
- Be sure the work area is well ventilated. Soldering produces smoke.
- While using the HAKKO FN-1010, don't do anything which may cause bodily harm or physical damage.

4. PARTS NAMES

4-1 Unit

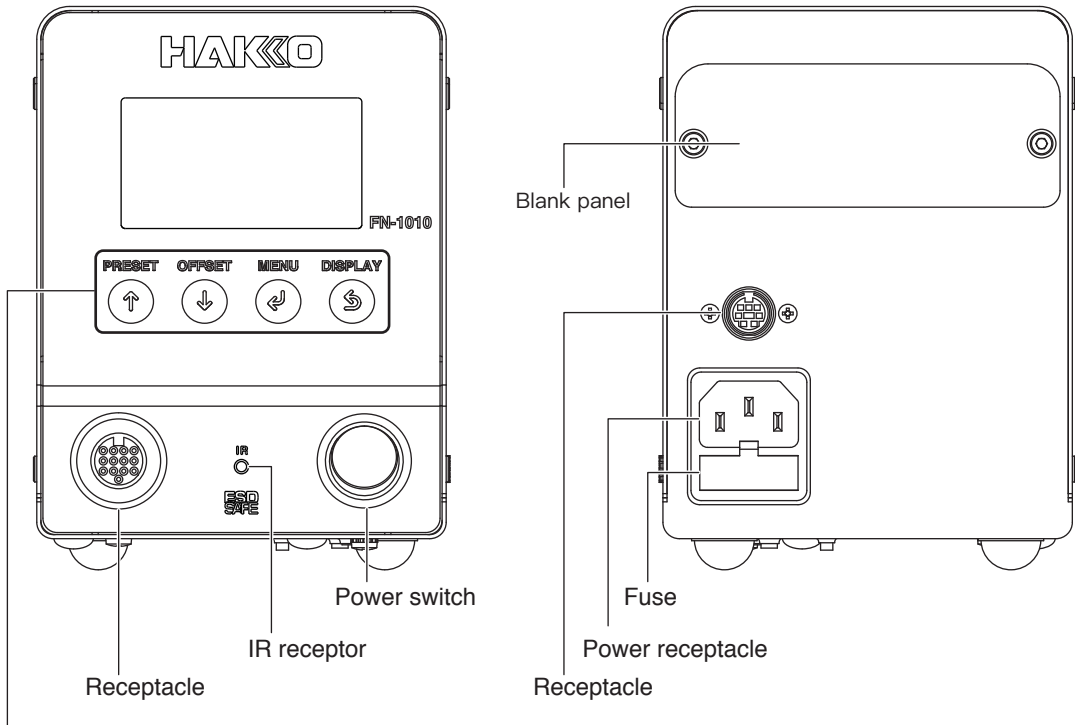

Control Buttons

The front panel of the HAKKO FN-1010 has 4 control buttons.

↑	In setting screen	Increases numerical values by 1 or moves cursor up one item.
	During normal operation	Opens preset selection screen.
↓	In setting screen	Decreases numerical values by 1 or moves cursor down one item.
	During normal operation	Opens offset setting screen.
↵	In setting screen	Confirms the numerical setting or item selection.
	During normal operation	Opens setting screen.
↶	In setting screen	Cancels input value and moves to previous screen.
	During normal operation	In normal screen, switches between digital display and graph display.

4-2 Normal display screen

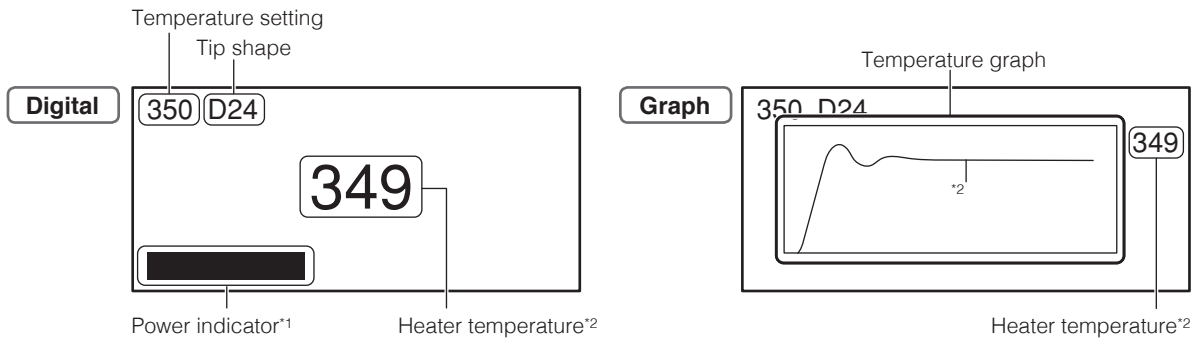

*1 Shows level of power input to heater

*2 The heater temperature and temperature graphs show the sensor values in the heater.

5. INITIAL SETUP

5-1 Iron holder

⚠ CAUTION

Be careful not to set the angle too high (close to vertical). Doing so will cause the grip to become hot.
Be careful not to set the angle too low. Doing so may let the soldering iron to fall out.

1. Loosen the two screws holding the iron receptacle (B5216), adjust it to the desired angle, and retighten the screws to secure it in place.

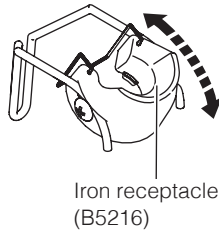

2. Insert the cleaning wire (A1561) into the tip cleaner (FT401-81) and attach the tip cleaner to the iron holder (FH210-81).

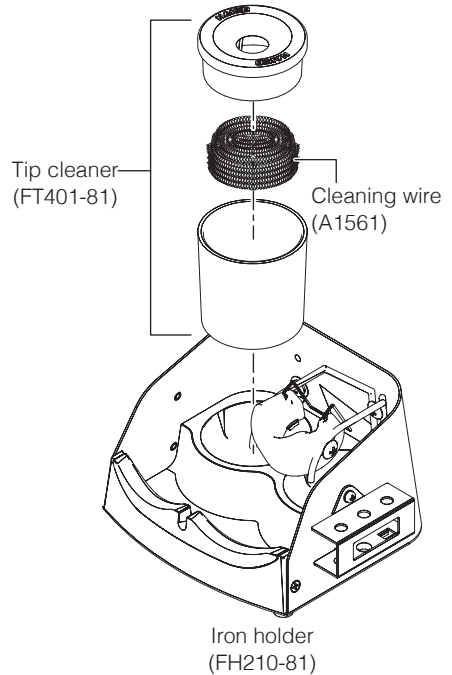

— Note —

It is possible to switch the left and right positions of the iron receptacle and cleaner.
Attach them in the locations which make them easiest to use.

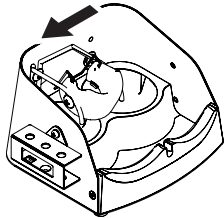

5-2 Handpiece

⚠ CAUTION

- The tip gets hot. Use sufficient care when handling it to avoid getting burned.
- When inserting or removing the tip, always be sure to switch the power off first.
- Once the tip has been fully inserted into the handpiece, do not try to forcibly push it in more.
If the tip is not inserted correctly, “Sensor error” will be displayed.

5-2-1 Inserting tip

1. Place the tip in the tip insertion stand on the side of the iron holder.
When putting the tip in, put it in the position matching the shape of the tip end.
2. Fix it by hand so that the soldering iron will not move.
Slide the handpiece (FN1101-81) fully onto the tip.

*1 When a 5.2D-type tip is used, place it here and then press-fit it into the handpiece. Otherwise, a 5.2D-type tip cannot be attached.

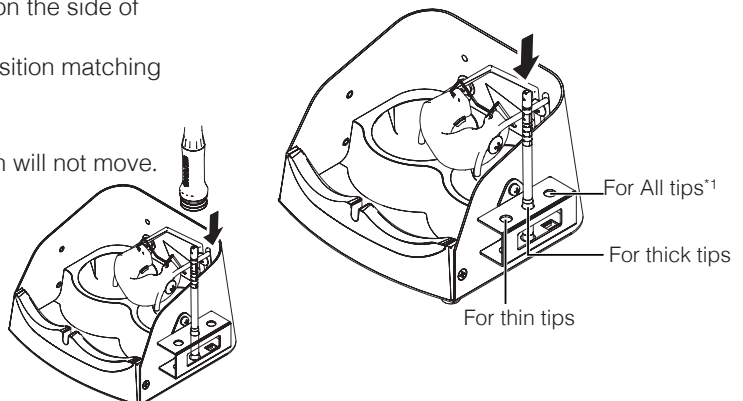

5-2-2 Removing tip

1. As shown in the diagram below, fit the handpiece (FN1101-81) into the tip removal attachment of the iron holder.
2. Fix it by hand so that the soldering iron will not move. Pull the handpiece (FN1101-81) toward you to remove the tip.

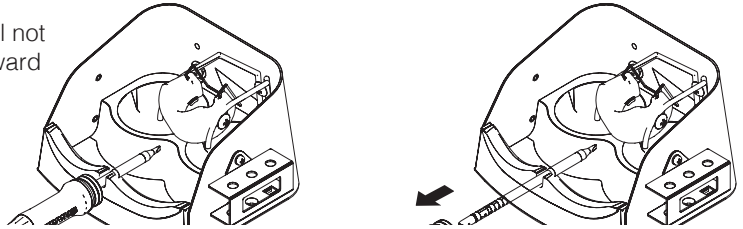

5-2-3 About tips

When a T36 tip is inserted into the handpiece, the station reads the tip information from the wavy-line section on the following figure.

The tip information can be checked from "Tip Info" on the menu screen.

It is possible to set the details on the "Tip Info" screen. (Refer to [6-7 Load repetition count alarm])

Tips (T36 series)

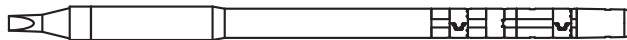

5-3 Station

⚠ CAUTION

- When connecting or disconnecting the soldering iron cord to/from the receptacle, always be sure to switch the power off first. Failure to do so may result in damage to the circuit board.
- This equipment has electrostatic discharge countermeasures and must be connected to ground when in use.

1. Connect the power cord to the power receptacle on the back of the station.
Connect the soldering iron cord to the receptacle on the front of the station.
2. Place the handpiece in the iron holder.
3. Plug the power cord plug into an electrical outlet.

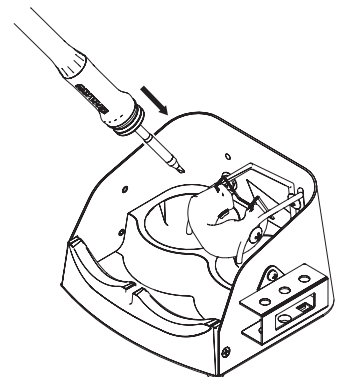
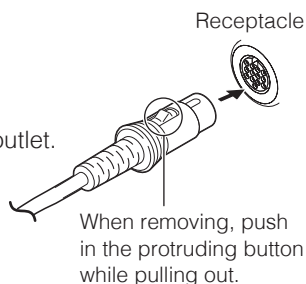

6. OPERATION

⚠ CAUTION

- At the time of shipment from the factory, the default temperature setting is 350°C.
- When not using, place the iron in the iron holder.

— Note —

Load repetition count function and supplied energy calculation function are influenced by factors such as tip shape, deterioration condition of tips, temperature setting, external environment and work size. Please use values as reference.

Set power switch to ON.

When turning on the power switch initially, it is necessary to set the date/time.

When the set temperature has been reached, a buzzer will sound to indicate that the iron is ready to use.

Input Time & Date

2018/01/01/00:00

6-1 Setting/changing the temperature

The temperature can be set or changed by the following steps. The settable temperature range is 50 – 450° (120 – 840°F).

1. With the normal screen shown, press the \uparrow button. The menu screen will appear. Select “Temp Set” and press the \uparrow button again.

Temp Set	350°C
Auto Cal	→
Auto Cal Info	→
Tip Info	→
Load Detection	OFF
Preset Temp	→
Offset Temp	00°C

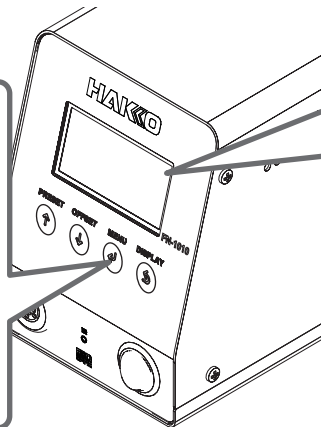

2. The temperature setting screen will appear. Press the \uparrow or \downarrow button to set the hundreds digit.*1 After setting, press the \uparrow button.

Set Temp
350°C

3. Following the same procedure as in Step 2, set the tens and ones digits.*2 After setting, press the \uparrow button.

Set Temp
400°C

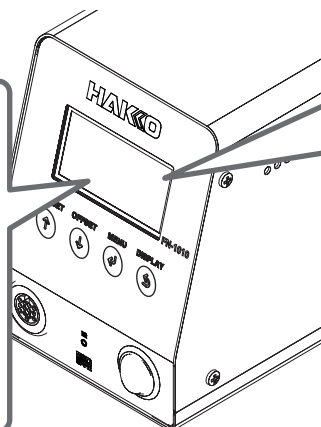

4. The set temperature will be stored in the internal memory, and after the new temperature setting has been displayed, heater control will start.

400 D24
400°C

*1 Values from 0 – 4 can be set. (In °F mode, values from 1 – 8 can be set.)

*2 Values from 0 – 9 can be set. (The range is the same in °F mode.)

6-2 Selecting a preset temperature

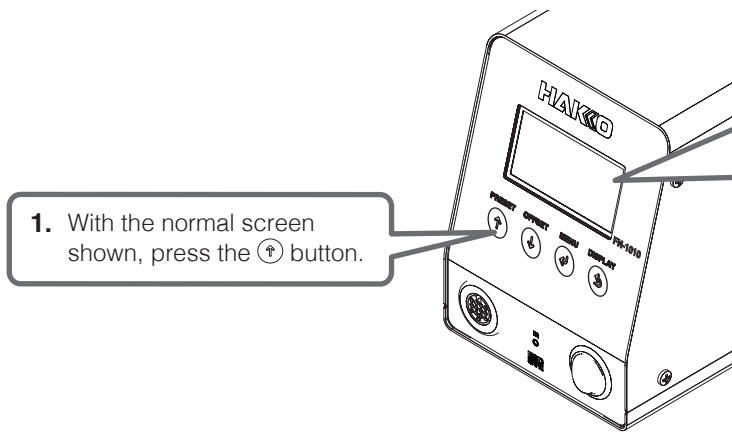

2. The preset selection screen will appear. Press the \uparrow or \downarrow button to select the desired Preset No. After selecting, press the \rightarrow button. The selection will be stored in the internal memory and after the new temperature setting has been displayed, heater control will start.

Preset Select	
Preset1	250°C
Preset2	300°C
Preset3	350°C
Preset4	400°C
Preset5	450°C

6-3 Setting/changing the offset

6-3-1 Direct input

The offset can be set or changed by the following steps. The settable offset range is $-50 - +50^{\circ}\text{C}$ ($-90 - +90^{\circ}\text{F}$). Example) When the set temperature is 400°C and the tip temperature is 395°C , the difference between them is 5°C .

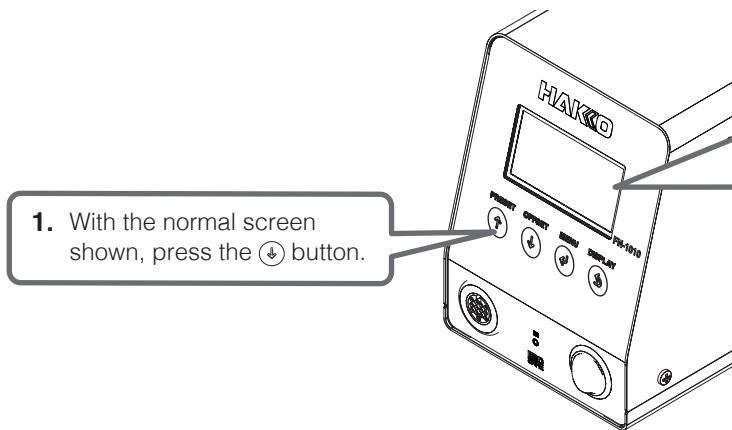

2. The offset input screen will appear. Press the \uparrow or \downarrow button to select blank (+) or -. After selecting, press the \rightarrow button.

Temp Offset	
	00°C

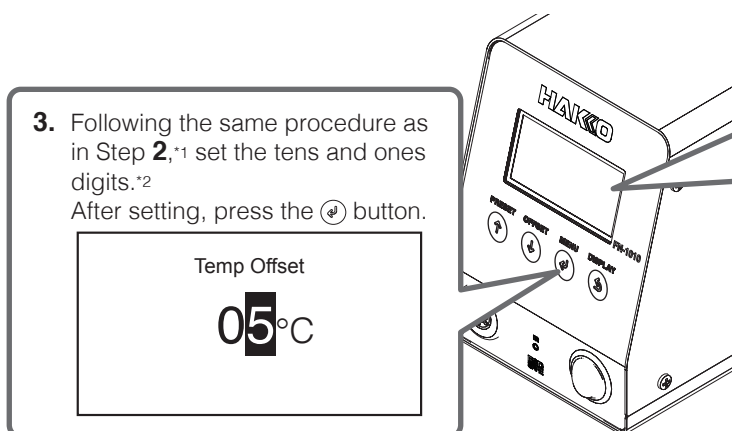

4. The new offset value will be stored in the internal memory, and heater control will start.

400 D24
400°C

*1 Values from 0 - 5 can be set. (In °F mode, values from 0 - 9 can be set.)

*2 Values from 0 - 9 can be set. (The range is the same in °F mode.)

6. OPERATION (continued)

6-3-2 IR input

In addition to direct input of the offset value as described in “6-3-1 Direct input”, the offset value can also be set using IR input.

Example) Using HAKKO FG-100B

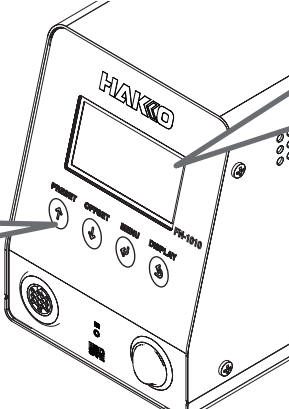
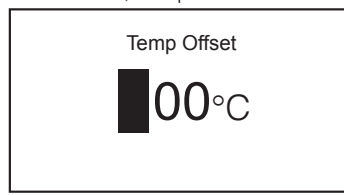
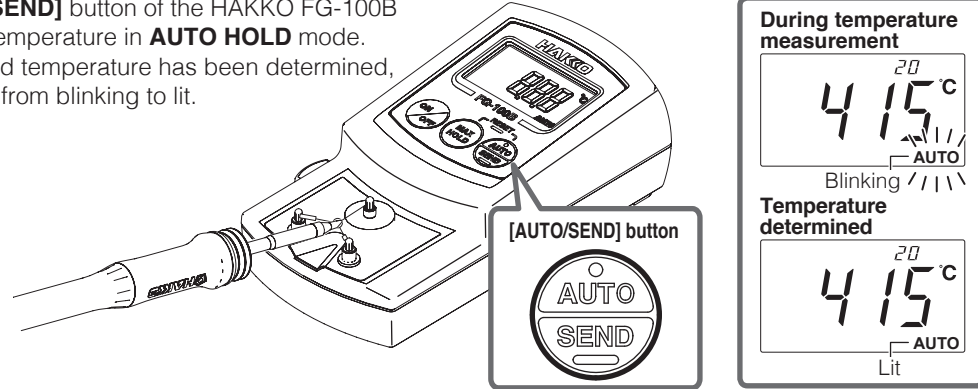
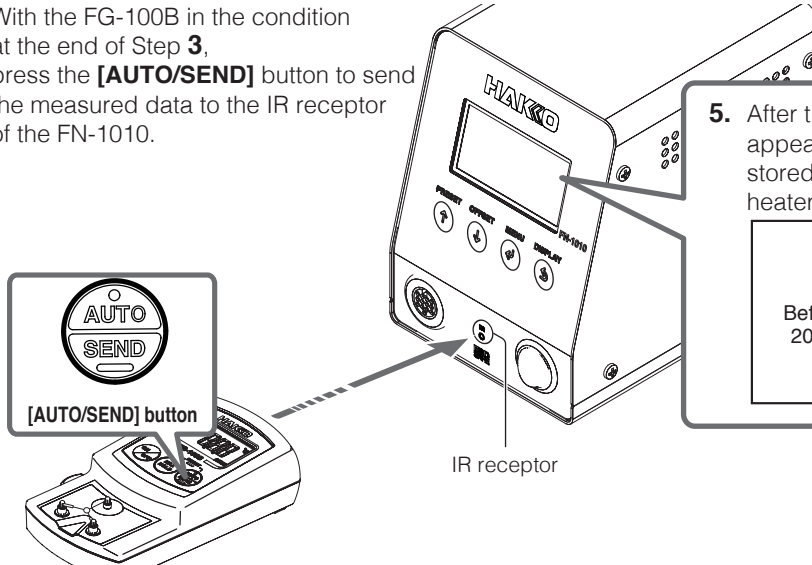
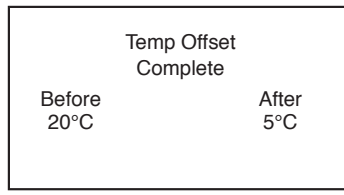

1. With the normal screen shown, press the \downarrow button.
2. The offset input screen will appear. In this state, the product is in standby.
3. Press the **[AUTO/SEND]** button of the HAKKO FG-100B and measure the temperature in **AUTO HOLD** mode. When the measured temperature has been determined, **AUTO** will change from blinking to lit.
4. With the FG-100B in the condition at the end of Step 3, press the **[AUTO/SEND]** button to send the measured data to the IR receptor of the FN-1010.
5. After the display shown below appears, the new offset value will be stored in the internal memory, and heater control will start.

— Note —

For details on using the thermometer equipped with IR transfer function, refer to the instruction manual for the thermometer being used.

6-4 Performing “Auto Cal”

When “Auto Cal” has been performed, if the measured temperature is within a previously set temperature range, it will be judged as passed and stored in the main body, and the product will return to normal operation. If the measured temperature is outside the temperature range, the offset value will be calculated from the measurement results, and control will be performed using the new offset value. Follow the instructions on the screen to send the measured results with the new offset value.

1. With the normal screen shown, press the  button. The menu screen will appear. Select “Auto Cal” and press the  button again.

Temp Set	400°C
Auto Cal	→
Auto Cal Info	→
Tip Info	→
Load Detection	OFF
Preset Temp	→
Offset Temp	00°C

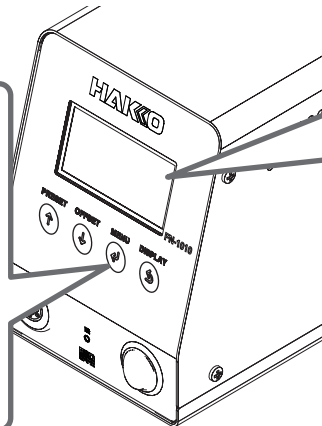

2. The “Auto Cal” standby screen will appear. Press the  button to enter the IR receiving standby condition.

Calibration	
Temperature	ON
Leak Volt	OFF
Tip-to-Ground	OFF
	START

4. Measure the temperature and press the **[AUTO/SEND]** button to send the measured data to the main body's IR receptor as described in Steps 3 and 4 of “6-3-2 IR input”.

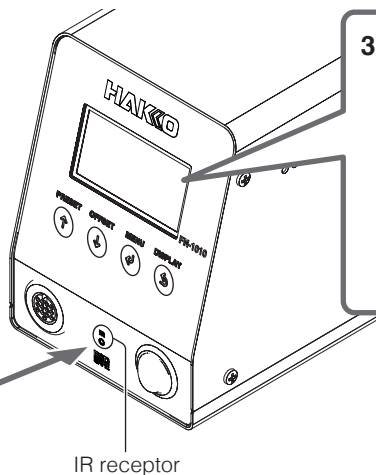
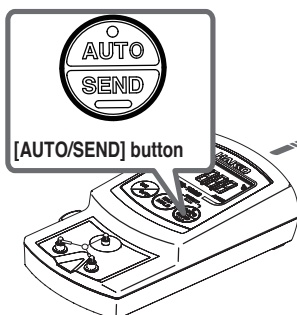

3. In IR receiving standby condition, the screen will be as shown below.

Calibration	
Offset	05°C
Range	-10°C ~ +10°C
	Send Data

5. If the measured data is within the set range it will be judged as passed. If it is outside the set range, temperature measurement and sending will be performed repeatedly for the previously set number of retries.

— Note —

If the measurement did not pass after Auto Cal was performed, the changed offset value will be returned to the value before calibration.

6. OPERATION (continued)

6-5 Checking “Auto Cal” information

- With the normal screen shown, press the \odot button. The menu screen will appear. Select “Auto Cal Info” and press the \odot button again.

Temp Set	400°C
Auto Cal	→
Auto Cal Info	→
Tip Info	→
Load Detection	OFF
Preset Temp	→
Offset Temp	00°C

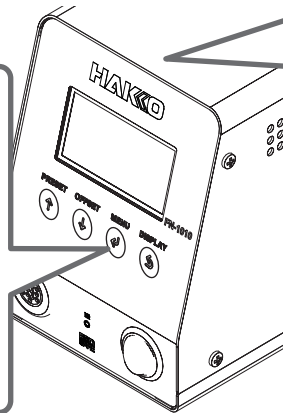

- A list of the calibration results for the most recent 10 calibrations will be shown. To see the details, use the \uparrow or \downarrow button to select the desired calibration from the list, and then press the \odot button.

Calibration Result List			
1.	2018/03/23	17:15	P
2.	2018/03/23	17:13	F
3.	2018/03/23	17:13	F
4.	2018/03/23	17:12	F
5.	2018/03/22	11:11	P

In the details screen, press the \uparrow or \downarrow button to change the page. After checking the information, press the \odot button.

6-6 Setting the load detection function

The HAKKO FN-1010 has the following functions for detecting the tip load.

Load repetition count function:

The number of times a specified load has occurred is counted and stored in the tip.

Supplied energy calculation function:

The amount of energy emitted during the period in which a load occurred is calculated.

- With the normal screen shown, press the \odot button. The menu screen will appear. Select “Load Detection” and press the \odot button again.

Temp Set	400°C
Auto Cal	→
Auto Cal Info	→
Tip Info	→
Load Detection	OFF
Preset Temp	→
Offset Temp	00°C

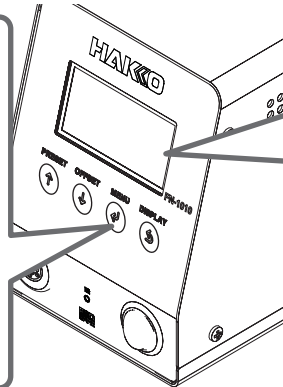

- The screen for setting the load detection function to ON or OFF will be shown. Use the \uparrow or \downarrow button to select “ON”.

Load Detection	
ON	OFF

6-7 Load repetition count alarm

If the specified number of load repetitions has been reached, the load repetition count alarm sounds a buzzer and vibrates the handpiece.

The count alarm value can be set according to the following procedure. The settable range is ----- (OFF) and 100 to 999,900.

- With the normal screen shown, press the \odot button. The menu screen will appear. Select “Tip Info” and press the \odot button again.

Temp Set	400°C
Auto Cal	→
Auto Cal Info	→
Tip Info	→
Load Detection	OFF
Preset Temp	→
Offset Temp	00°C

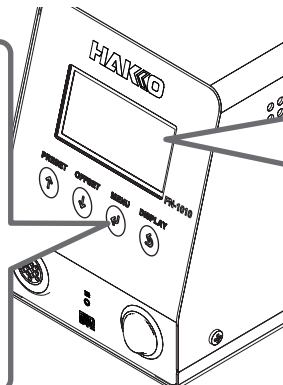

- The screen for checking and setting tip information will be shown. Use the \uparrow or \downarrow button to select “Count Alm” and press the \odot button.

Shape	T36-D24
Load Count	000000
PWR Time	00000000:00
Count Alm	OFF
Load Sensitivity	3
Tip Solder Type	LF
SerialNo.	*****

3. The count alarm value input screen will be shown. Select "ON" and press the \oplus or \ominus button to set the first digit.*1 After setting, press the \Rightarrow button.

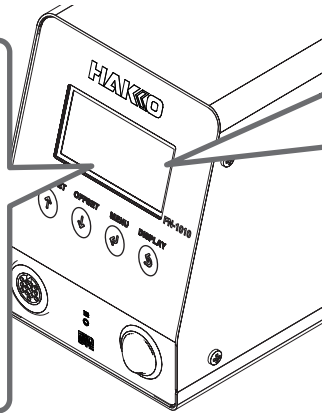
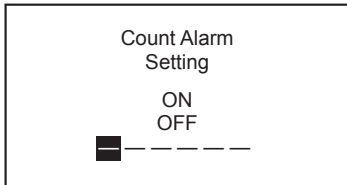

4. Following the same procedure as in Step 3, set the second, third, and fourth digits.*1 After setting, press the \Rightarrow button.

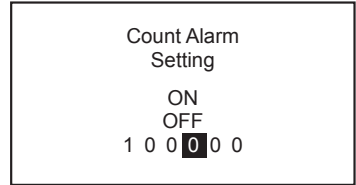

*1 Values from 0 – 9 can be set. (The range is the same in °F mode.)

Other items which can be set on the HAKKO FN-1010 include contrast adjustment, preset temperature settings, etc.

Detailed information on how to change parameter details, etc. are described in the instruction manuals available from the HAKKO Document Portal. Please download the desired documents from there.

➡ <https://doc.hakko.com>

7. MAINTENANCE

Performing proper and periodical maintenance extends the products life and contributes to use it always in a good condition. Efficient soldering depends upon the temperature, the quality and quantity of the solder and flux. Apply the following service procedure as dictated by the conditions of the usage.

⚠ WARNING

Since the soldering iron can reach a very high temperature, please work carefully. Except the case especially indicated, always turn the power switch OFF and disconnect the power plug before performing any maintenance procedure.

⚠ CAUTION

NEVER file the tip to remove oxides!

1. Set the temperature to 250°C. (482°F.)
2. When the temperature stabilizes, clean the tip (see “Cleaning”, below) and check the condition of the tip. If the tip is badly worn or deformed, replace it.
3. If the solder plated part of the tip is covered with black oxide, apply fresh solder, containing flux, and clean the tip again.
Repeat until all the oxide is removed, then coat the tip with fresh solder.
4. Turn the power OFF and remove the tip, using the heat resistant pad. Set the tip aside to cool.
5. Remaining oxides, such as the yellow discoloration on the tip shaft, can be removed with isopropyl alcohol.

— Notes —

Tip temperature	High temperatures shorten tip life and may cause thermal shock to components. Always use the lowest possible temperature when soldering. The excellent thermal recovery characteristics of the HAKKO FN-1010 ensure effective soldering at low temperatures.
Cleaning	Always clean the soldering tip before use, to remove any residual solder or flux adhering to it. Use the tip cleaner. Contaminants on the tip have many deleterious effects, including reduced heat conductivity, which contribute to poor soldering performance.
After use	Always clean the tip and coat it with fresh solder after use. This guards against oxidation.
When the unit is not being used and the auto power shutoff is not active.	Never allow the unit to idle at a high temperature for extended periods. This will allow the tip to become oxidized. Turn the power switch OFF. If it is to be out of service for several hours, it is advisable to pull the power plug as well.

8. TROUBLE SHOOTING GUIDE

⚠ WARNING

Before checking the inside of the HAKKO FN-1010 or replacing parts, be sure to disconnect the power plug. Failure to do so may result in electric shock.

The unit does not operate when the power switch is turned on.	CHECK	Is the power cord and/or the connection plug disconnected?
	ACTION	Connect it.
The tip does not heat up. The "Sensor Error" is displayed.	CHECK	Is the fuse blown?
	ACTION	Investigate why the fuse blew and then replace the fuse. If the cause can not be determined, replace the fuse. If the fuse blows again, send the unit in for repair.
	CHECK	Is the tip for HAKKO FN-1101 soldering iron?
	ACTION	Turn the power switch OFF and insert the genuine HAKKO FN-1101 tip. Turn the power switch ON.
	CHECK	Is the tip inserted properly?
	ACTION	Insert the tip completely.
Solder does not wet the tip.	CHECK	Is the connection cord and/or the heater/sensor broken?
	ACTION	See the appropriate section of this manual regarding how to check the connection cord and/or the heater/sensor for breakage. Measure the resistance of the heater and sensor while at room temperature, and it should be $5\Omega \pm 10\%$.
The tip temperature is too high.	CHECK	Is the tip temperature too high?
	ACTION	Set the appropriate temperature.
The tip temperature is too low.	CHECK	Is the tip contaminated with oxide?
	ACTION	Remove the oxide (see "7. MAINTENANCE".).
The tip temperature is too high.	CHECK	Is the connection cord broken?
	ACTION	If the connection code is broken, replace the HAKKO FN-1101.
The tip temperature is too low.	CHECK	Is the entered offset value correct?
	ACTION	Enter the correct value.
The low-temperature alarm tolerance error occurs frequently.	CHECK	Is the tip contaminated with oxide?
	ACTION	Remove the oxide (see "7. MAINTENANCE".).
Heater terminal short circuit error is displayed.	CHECK	Is the tip contaminated with oxide?
	ACTION	Remove the oxide (see "7. MAINTENANCE".).
The low-temperature alarm tolerance error occurs frequently.	CHECK	Is the tip too small for the items to be soldered?
	ACTION	Use a tip with a larger thermal capacity.
Heater terminal short circuit error is displayed.	CHECK	Is the setting value for the low-temperature alarm tolerance too low?
	ACTION	Increase the setting value.
Heater terminal short circuit error is displayed.	CHECK	Is the tip for HAKKO FN-1101 soldering iron?
	ACTION	Turn the power switch OFF and insert the genuine HAKKO FN-1101 tip. Turn the power switch ON.



※ 各言語（日本語、英語、中国語、フランス語、ドイツ語、韓国語）の取扱説明書は以下のURL、HAKKO Document Portalからダウンロードしてご覧いただけます。
 （商品によっては設定の無い言語がありますが、ご了承ください）
 * 各言語（日本語、英語、中文、法語、ドイツ語、韓国語）の使用説明書可以通过以下网站的HAKKO Document Portal 下载参阅。
 （有一部分的產品沒有設定外語對應，請見諒）
 * Instruction manual for the language, Japanese, English, Chinese, French, German and Korean can be downloaded from the following URL, HAKKO Document Portal.
 (Please note that some language may not be available depending on the product.)



<https://doc.hakko.com>



HAKKO CORPORATION

HEAD OFFICE

4-5, Shiohara 2-chome, Naniwa-ku, Osaka 556-0024 JAPAN
TEL: +81-6-6561-3225 FAX: +81-6-6561-8466
<http://www.hakko.com> E-mail: sales@hakko.com

OVERSEAS AFFILIATES

U.S.A.: AMERICAN HAKKO PRODUCTS, INC.

TEL: (661) 294-0090 FAX: (661) 294-0096

Toll Free (800)88-HAKKO

<http://www.hakkousa.com>

HONG KONG: HAKKO DEVELOPMENT CO., LTD.

TEL: 2811-5588 FAX: 2590-0217

<http://www.hakko.com.hk>

E-mail: info@hakko.com.hk

SINGAPORE: HAKKO PRODUCTS PTE., LTD.

TEL: 6748-2277 FAX: 6744-0033

<http://www.hakko.com.sg>

E-mail: sales@hakko.com.sg

Please access to the following address for the other Sales affiliates.

<http://www.hakko.com>

© 2018 HAKKO Corporation. All Rights Reserved.
Company and product names are trademarks or registered
trademarks of their respective companies.